

# IoT Gateway

Intel® Apollo Lake N3350 1.1 GHz

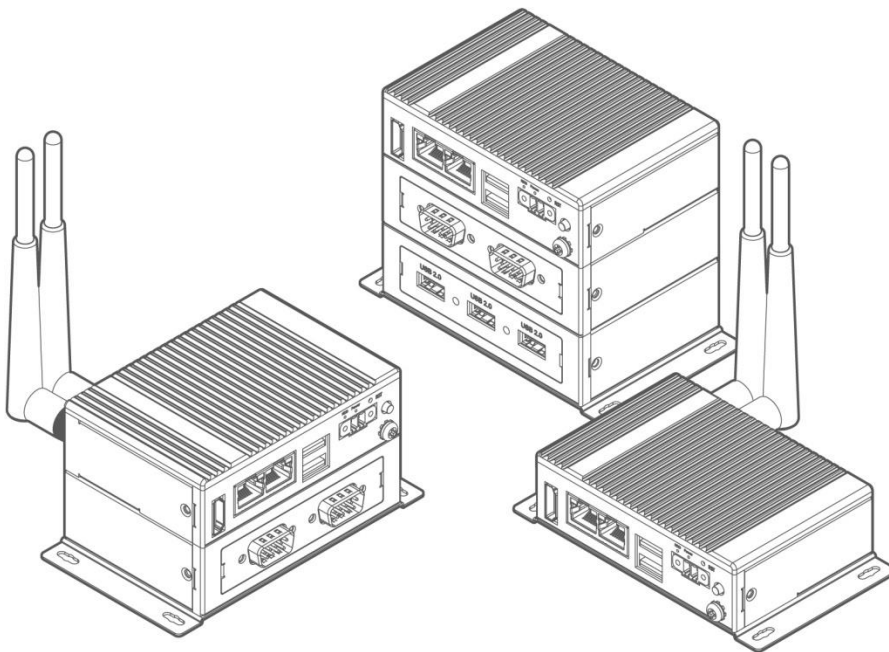

**EAC Mini EACIL20**

# User Manual

Version 1.0



# CONTENTS

**PREFACE ..... - 3 -**

**ABOUT THIS USER MANUAL ..... - 10 -**

**CHAPTER 1: INTRODUCTION..... - 12 -**

    1.1 Overview..... - 12 -

    1.2 Product Features ..... - 12 -

    1.3 Expansion Module ..... - 12 -

    1.3 Hardware Specifications ..... - 13 -

    1.4 Package Contents..... - 15 -

    1.5 Appearance..... - 16 -

    1.6 Dimensions ..... - 17 -

    1.7 LED Indicators ..... - 18 -

**CHAPTER 2: HARDWARE INSTALLATION..... - 20 -**

    2.1 Connectors..... - 20 -

        2.1.1 HDMI Connector ..... - 20 -

        2.1.2 Ethernet Connector ..... - 20 -

        2.1.3 USB Connector ..... - 21 -

        2.1.4 Power Connector ..... - 21 -

    2.2 Hardware Installation ..... - 22 -

        2.2.1 mSATA Installation..... - 22 -

        2.2.2 External Antenna Installation..... - 22 -

        2.2.3 Expansion Module Installation..... - 23 -

    2.3 Connecting the Power..... - 24 -

        2.3.1 Connecting the Power ..... - 24 -

        2.3.2 Chassis Grounding..... - 24 -

**CHAPTER 3: MOUNTING..... - 26 -**

    3.1 Wall/ Desk Mount..... - 26 -

    3.2 DIN-Rail Mount ..... - 27 -

    3.3 VESA Mount ..... - 28 -

**CHAPTER 4: INSYDE UEFI BIOS SETUP ..... - 30 -**

    4.1 How and When to Use BIOS Setup ..... - 30 -

    4.2 BIOS Functions..... - 32 -

- 4.2.1 Main Menu .....- 32 -
- 4.2.2 Advanced Settings .....- 33 -
- 4.2.4 Security Menu .....- 51 -
- 4.2.5 Power Menu .....- 52 -
- 4.2.3 Boot Menu.....- 55 -
- 4.2.3 Exit Menu .....- 57 -
- 4.3 Using Recovery Wizard to Restore Computer.....- 58 -
- 4.4 How to Enable Watchdog .....- 59 -
- CHAPTER 5: DRIVER INSTALLATION .....- 62 -**
- 5.1 Chipset Driver Installation .....- 62 -
- 5.2 Graphic Driver Installation.....- 64 -
- 5.3 TXE (Trusted Execution Engine) Driver Installation .....- 67 -
- 5.4 Serial IO Driver Installation .....- 70 -
- 5.5 LAN Driver Installation .....- 73 -
- CHAPTER 6: TECHNICAL SUPPORT .....- 77 -**
- 6.1 Software Developer Support.....- 77 -
- 6.2 Problem Report Form .....- 77 -
- APPENDIX A: ORDERING INFORMATION .....- 79 -**

## **PREFACE**

### **Copyright Notice**

No part of this document may be reproduced, copied, translated, or transmitted in any form or by any means, electronic or mechanical, for any purpose, without the prior written permission of the original manufacturer.

### **Trademark Acknowledgement**

Brand and product names are trademarks or registered trademarks of their respective owners.

### **Disclaimer**

We reserve the right to make changes, without notice, to any product, including circuits and/or software described or contained in this manual in order to improve design and/or performance. We assume no responsibility or liability for the use of the described product(s) conveys no license or title under any patent, copyright, or masks work rights to these products, and make no representations or warranties that these products are free from patent, copyright, or mask work right infringement, unless otherwise specified. Applications that are described in this manual are for illustration purposes only. We make no representation or guarantee that such application will be suitable for the specified use without further testing or modification.

### **Warranty**

Our warranty guarantees that each of its products will be free from material and workmanship defects for a period of one year from the invoice date. If the customer discovers a defect, we will, at his/her option, repair or replace the defective product at no charge to the customer, provide it is returned during the warranty period of one year, with transportation charges prepaid. The returned product must be properly packaged in its original packaging to obtain warranty service. If the serial number and the product shipping data differ by over 30 days, the in-warranty service will be made according to the shipping date. In the serial numbers the third and fourth two digits give the year of manufacture, and the fifth digit means the month (e. g., with A for October, B for November and C for December).

For example, the serial number 1W17Axxxxxxx means October of year 2017.

## **Customer Service**

We provide a service guide for any problem by the following steps: First, visit the website of our distributor to find the update information about the product. Second, contact with your distributor, sales representative, or our customer service center for technical support if you need additional assistance.

You may need the following information ready before you call:

- Product serial number
- Software (OS, version, application software, etc.)
- Detailed description of the problem
- The exact wording of error messages

In addition, free technical support is available from our engineers every business day. We are always ready to give advice on application requirements or specific information on the installation and operation of any of our products.

## Advisory Conventions

Four types of advisories are used throughout the user manual to provide helpful information or to alert you to the potential for hardware damage or personal injury. These are Notes, Important, Cautions, and Warnings. The following is an example of each type of advisory.

**NOTE:**

A note is used to emphasize helpful information

**IMPORTANT:**

An important note indicates information that is important for you to know.

**CAUTION**

A Caution alert indicates potential damage to hardware and explains how to avoid the potential problem.

**WARNING!**

An Electrical Shock Warning indicates the potential harm from electrical hazards and how to avoid the potential problem.

**ALTERNATING CURRENT**

The Protective Conductor Terminal (Earth Ground) symbol indicates the potential risk of serious electrical shock due to improper grounding.

## Safety Information

**WARNING!**

Always completely disconnect the power cord from your chassis whenever you work with the hardware. Do not make connections while the power is on. Sensitive electronic components can be damaged by sudden power surges. Only experienced electronics personnel should open the PC chassis.

**WARNING!**

During heavy loading in 50°C environment, the top side of the EAC Mini may be over 70°C. Please do not touch these parts with your bare hands.

**CAUTION**

Always ground yourself to remove any static charge before touching the CPU card. Modern electronic devices are very sensitive to static electric charges. As a safety precaution, use a grounding wrist strap at all times. Place all electronic components in a static-dissipative surface or static-shielded bag when they are not in the chassis.



## Safety Precautions

For your safety carefully read all the safety instructions before using the device. All cautions and warnings on the equipment should be noted. Keep this user manual for future reference.



### CAUTION

Do not cover the openings!

**\*Let service personnel to check the equipment in case any of the following problems appear:**

- The power cord or plug is damaged.
- Liquid has penetrated into the equipment.
- The equipment has been exposed to moisture.
- The equipment does not work well or you cannot get it to work according to the user manual.
- The equipment has been dropped and damaged.
- The equipment has obvious signs of breakage.
- Do not leave this equipment in an uncontrolled environment where the storage temperature is below -20°C (-4°F) or above 60°C (140°F). It may damage the equipment.



### CAUTION

Use the recommended mounting apparatus to avoid risk of injury.



### WARNING!





Only use the connection cords that come with the product. When in doubt, please contact the manufacturer.



### WARNING!

Always ground yourself against electrostatic damage to the device.

## Important Information

Countries/ Area	Symbol	This equipment complies with essential requirements of:
 USA		FCC Part 15 Subpart B Regulations Class B
 European Union		Electromagnetic Compatibility Directive(2014/30/EU) Low Voltage Directive (2014/35/EU) Restrictions of the use of certain hazardous substances (RoHS) Directive (2011/65/EU)

## Federal Communications Commission Radio Frequency Interface Statement

This device complies with part 15 FCC rules.

Operation is subject to the following two conditions:



- This device may not cause harmful interference.
- This device must accept any interference received including interference that may cause undesired operation.

This equipment has been tested and found to comply with the limits for a class "B" digital device, pursuant to part 15 of the FCC rules. These limits are designed to provide reasonable protection against harmful interference when the equipment is operated in a commercial environment. This equipment generates, uses, and can radiate radio frequency energy and, if not installed and used in accordance with the instruction manual, may cause harmful interference to radio communications. Operation of this equipment in a residential area is likely to cause harmful interference in which case the user will be required to correct the interference at his own expense.

## European Union



This equipment is in conformity with the requirement of the following EU legislations and harmonized standards. Product also complies with the Council directions.

### **Electromagnetic Compatibility Directive (2014/30/EU)**

- EN55024: 2010+A1: 2015
  - IEC61000-4-2: 2009
  - IEC61000-4-3: 2006+A1: 2007+A2: 2010
  - IEC61000-4-4: 2012
  - IEC61000-4-5: 2014
  - IEC61000-4-6: 2014
  - IEC61000-4-8: 2010
  - IEC61000-4-11: 2004
- EN 55032: 2015+AC: 2016
- EN61000-3-2:2014
- EN61000-3-3:2013

### **Low Voltage Directive (2014/35/EU)**

- EN 60950-1:2006/A11:2009/A1:2010/A12:2011/ A2:2013

## ABOUT THIS USER MANUAL

This User Manual provides information about using the Winmate® EAC Mini EACIL20 IoT Gateway.

The documentation set for the Winmate® EAC Mini EACIL20 IoT Gateway provides information for specific user needs, and includes:

- **EAC Mini EACIL20 Quick Start Guide** - describes how to get the box computer up and running.
- **EAC Mini EACIL20 User Manual** – contains detailed description on how to use the display, its components and features.



**NOTE:**

Some pictures in this guide are samples and can differ from actual product.

## Revision History

Version	Date	Note
1.0	6-Oct-2017	Preliminary release

## **INTRODUCTION**

This chapter provides the EAC Mini EACIL20 IoT Gateway product overview, describes its features and hardware specifications.



# CHAPTER 1: INTRODUCTION

This chapter provides the EAC Mini EACIL20 IoT Gateway product overview, describes its features and hardware specifications.

## 1.1 Overview

Congratulations on purchasing Winmate® EAC Mini EACIL20 IoT Gateway

The EAC Mini EACIL20 is a compact industrial IoT Gateway with low power consuming Intel® Apollo Lake N3350 1.1 GHz processor. The EAC Mini provides great expansion including one Mini-PCIe and SIM card support. Expansion module offers great options from additional USB ports to Bluetooth 4.0, Wi-Fi and 4G. Wireless connectivity and all necessary input and output ports allow the EAC Mini to send data from manufacturing facilities directly to cloud server.

Abundant I/O ports and expansion module with more than thirty different combinations make EAC Mini is suitable for smart factory and machine automation applications.

## 1.2 Product Features

Winmate® EAC Mini IoT Gateway offers the following features:

- Intel® Apollo Lake N3350 1.1 GHz
- Fanless cooling system
- Compact size 100 x 70 x 31 mm (w/o mounting bracket)
- Expansion module with 30+ combinations, including 4G/3G/Wi-Fi/Bluetooth
- Various mounting options: desk, wall, VESA, din-rail, pole
- Suitable for smart factory applications

## 1.3 Expansion Module

30+ combinations:

- 4G
- 3G
- 3-port RS232/422/485 w/ isolation
- 24-Channel Digital I/O w/ isolation
- 2-port CANBUS w/ isolation
- 4-port USB 2.0
- 2-port RS232/422/485 w/ isolation

## 1.3 Hardware Specifications

		<b>Model Name</b>
		<b>EACIL20</b>
<b>System Specification</b>	CPU	Intel® Apollo Lake N3350 1.1 GHz
	Graphics Engine	Intel® HD Graphics
	BIOS	Insyde UEFI
	Watchdog Timer	Programmable 256 levels, timer interval 1 to 255 sec.
	Technology	4GB LPDDR3 1866MHz
<b>Storage</b>	eMMC	Onboard 32 GB
	mSATA	Optional
<b>Expansion</b>	mPCIe	1 x Full-size mPCIe slot
	USB Wafer	2 x USB Wafer
<b>External I/O</b>	USB	2 x USB3.0
	Ethernet	2 x Giga LAN RJ45 Connector
	HDMI	1 x HDMI, supports 1920 x 1080@60 Hz
<b>Power Management</b>	Power Supply	9V to 36V DC, 2-Pin Terminal Block
	Grounding Protection	Chassis Grounding
<b>Buttons and LED Indicators</b>	LED Indicator	1 x Power
	Button	1 x Power Button 1 x Reset Button
<b>Mechanical Specification</b>	Dimensions	100 (W) x 70 (H) x 31(D) mm (One layer) 100 (W) x 70 (H) x 61(D) mm (Double layer)

	Weight	0.6 kg (One layer), 0.7 kg (double layer)
	Mounting	Desk Mounting (Default), Wall Mounting (Default), VESA Mounting (Optional), DIN-Rail Mounting (Optional), Pole Mounting (Optional)
	Cooling System	Fanless
	Enclosure	Metal Housing
<b>Environment</b>	Operating Temp.	0~50° C (32~122° F)
	Storage Temp.	0~70° C (32~158° F)
	Operating Humidity	10~95% RH @ 40°C (non-condensing)
	Shock	Operating, IEC 60068-2-27
	Vibration	Operating, IEC 60068-2-64
	IP Rating	IP30
<b>Certificate</b>	EMC & Safety	CE, FCC
<b>Operating System (Optional)</b>	OS	Windows® 10 IoT Core Windows® 10 IoT Enterprise Linux Ubuntu





## 1.4 Package Contents

Carefully remove the box and unpack EAC Mini EACIL20 IoT Gateway. Please check if all the items listed below are inside your package. If any of these items are missing or damaged contact us immediately.

Carefully remove the box and unpack your device. Please check if all the items listed below are inside your package. If any of these items are missing or damaged contact us immediately.

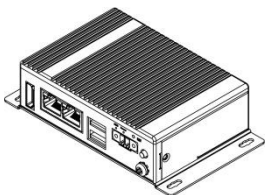
Standard factory shipment list:

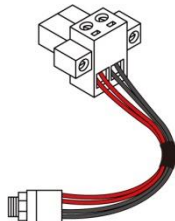
			
<b>EAC Mini IoT Gateway</b>	<b>Quick Start Guide (Hardcopy)</b>	<b>Driver CD</b>	<b>Terminal Block 2 pin to 2.5Ø Female Adapter Cable</b>
Varies by product specifications	915211101025	917111101000	94J602G020K2

Your package may include optional accessories based on your order:

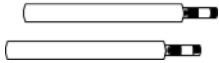
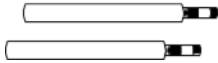
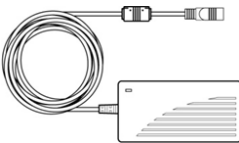
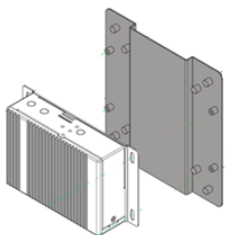
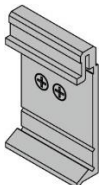
			
<b>WLAN External Antenna</b>	<b>WWAN External Antenna</b>	<b>AC Adapter 12V/ 40W</b>	<b>VESA Mounting Kit</b>
397SM0000002	39700000000H	9220123C6000	821118561001
			
<b>DIN Rail Mounting Kit</b>			
821118551400			

## 1.5 Appearance

This section includes front and rear side I/O ports location of the EAC Mini IoT Gateway.

Front Side

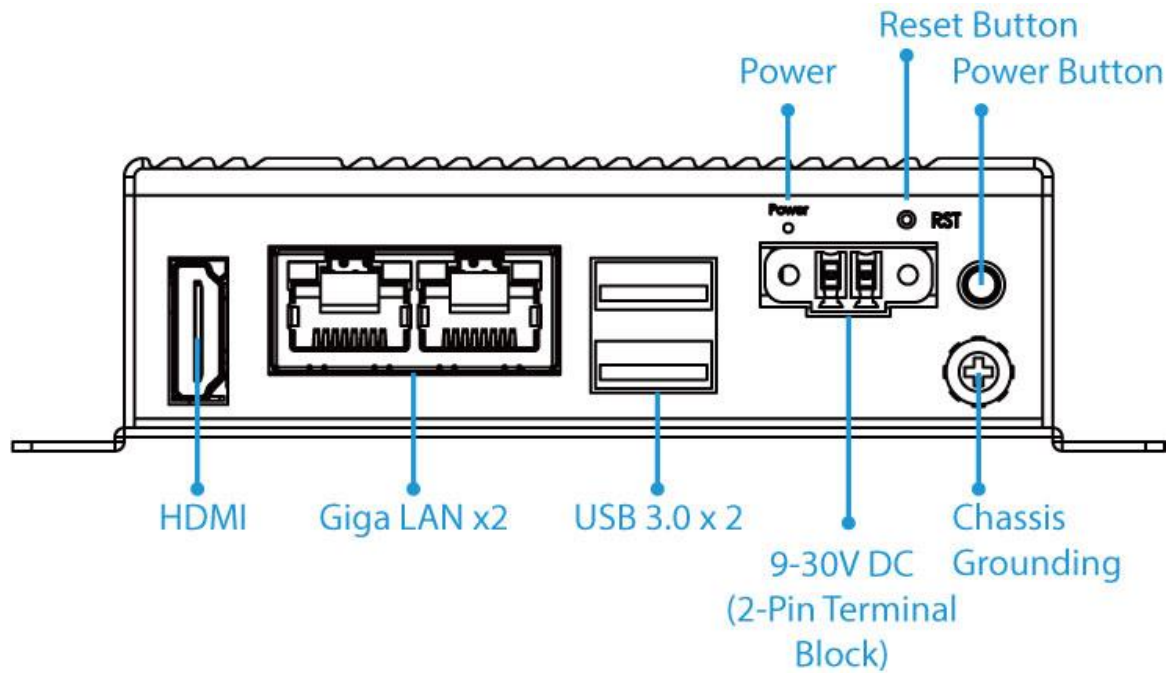

Rear Side

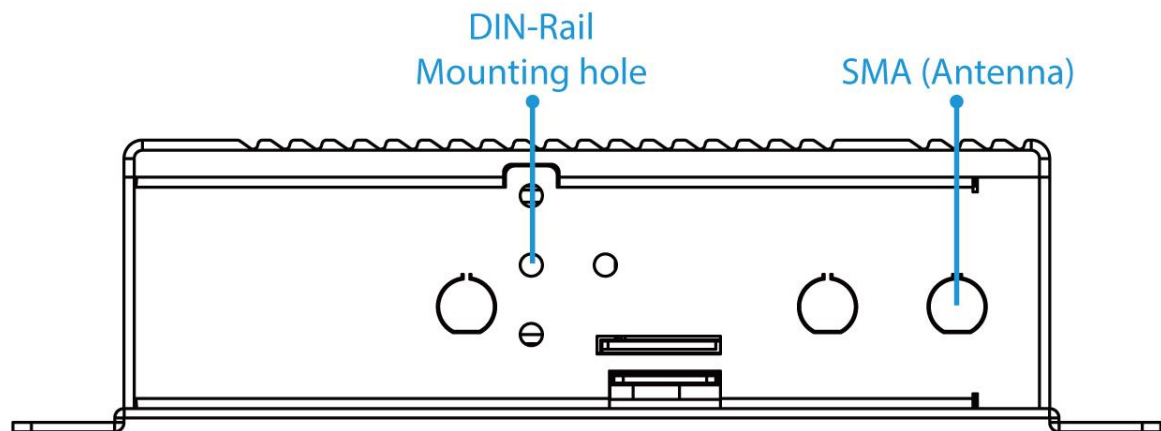

## 1.6 Dimensions

All dimensions shown in mm (millimeters).

### Unit without mounting bracket

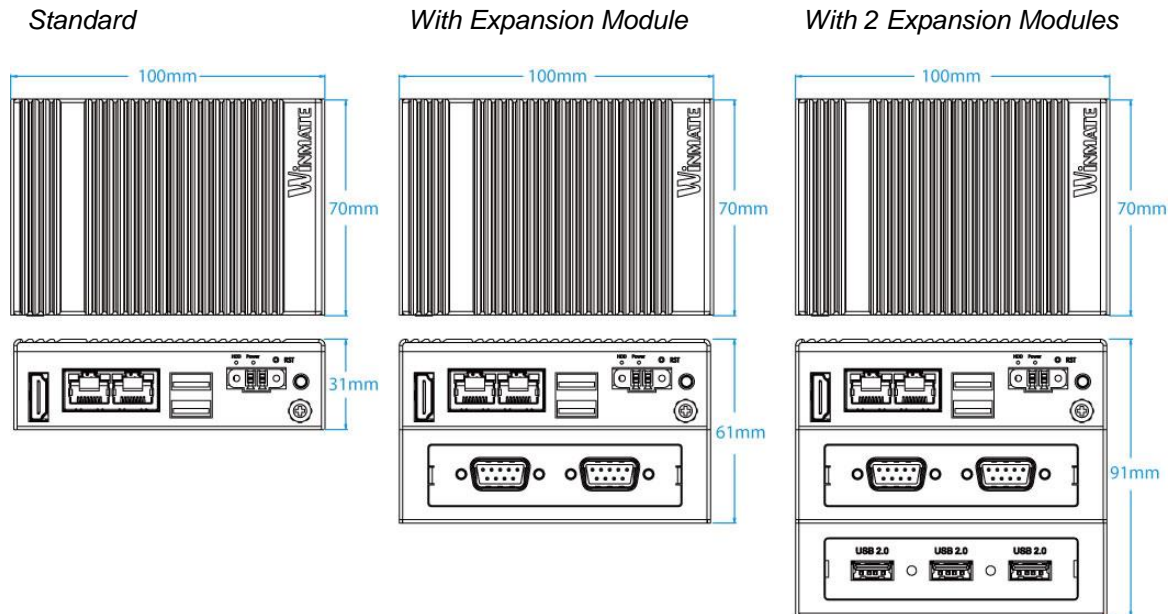

### Unit with mounting bracket

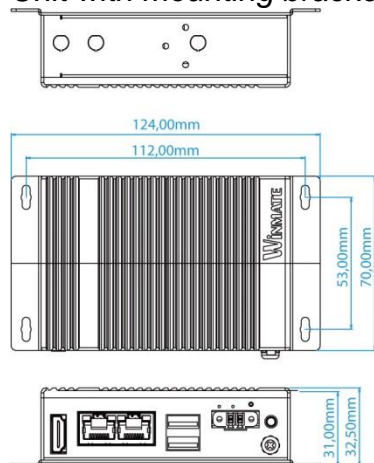

## 1.7 LED Indicators

The EAC Mini IoT Gateway provides one HDD and one Power LED indicators located on the front for status monitoring.

LED Type	Status	Description
Power	On	Power is on
	Off	Power is off

## **HARDWARE INSTALLATION**

This chapter provides information on how to use external I/O and the installation of EAC Mini EACIL20 IoT Gateway hardware.



## CHAPTER 2: HARDWARE INSTALLATION

This chapter provides information on how to use external I/O and the installation of EAC Mini EACIL20IoT Gateway hardware.

### 2.1 Connectors

This section describes all the external connectors located on the EAC Mini IoT Gateway.

The following sections give you information about EAC Mini standard connectors and pin assignments.

#### 2.1.1 HDMI Connector

Plug HDMI signal cable to the HDMI connector of the EAC Mini EACIL20, and plug the other end to the monitor.

##### *Pin Assignment and signal names for HDMI connector*



Pin №	Signal Name	Pin №	Signal Name
1	HDMI_RX2+	2	GND
3	HDMI_RX2-	4	HDMI_RX1+
5	GND	6	HDMI_RX1-
7	HDMI_RX0+	8	GND
9	HDMI_RX0-	10	HDMI_RXC+
11	GND	12	HDMI_RXC-
13	HDMI_CON_CEC	14	NC
15	HDMI_CON_SCL	16	HDMI_CON_SDA
17	HDMI_CON_CABLE	18	+5V_HDMI
19	HDMI_CON_HP		

#### 2.1.2 Ethernet Connector

The EAC Mini EACIL20 has two Ethernet connectors located on the front. Ethernet ports provide a standard RJ45 10/100/1000 Mbps jack connector with LED indicators on the front side to show its Active/ Link status and Speed status.

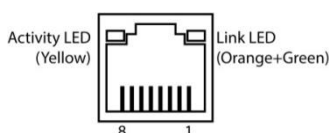

10/100 Mbps- Green  
1G Mbps – Orange

Pin №	Signal Name	Pin №	Signal Name
1	TX1+	2	TX1-
3	TX2+	4	TX3+
5	TX3-	6	TX2-
7	TX4+	8	TX4-

### **2.1.3 USB Connector**

The EAC Mini EACIL20 provides two USB 3.0 connectors. Use USB 3.0 connector to connect external devices such as mouse or keyboard to the box computer.

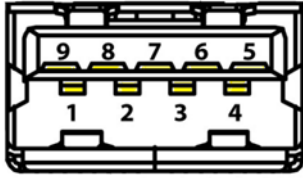

Pin №	Signal Name	Pin №	Signal Name
1	+5V	2	USB_D-
3	USB_D+	4	GND
5	STDA_SSRX-	6	STDA_SSRX+
7	GND	8	STDA_SSTX-
9	STDA_SSTX+		

### **2.1.4 Power Connector**

DC power source input is a 2 pin terminal block connector. Power Input is 9V to 36V DC in.



- +

## 2.2 Hardware Installation

This chapter describes how to install optional expansion module in the system.



### CAUTION

Always remove the power cord before installing the hardware.

### 2.2.1 mSATA Installation

*To insert mSATA:*

1. Unscrew the four screws on the bottom cover.
2. Plug in mSATA card with into the mPCIe slot.
3. Screw the two screws on board to fix mSATA.
4. Screw back the bottom cover.

### 2.2.2 External Antenna Installation

Notice that external antenna is an optional feature of the EAC Mini EACIL20.

*To install external SMA antenna:*

1. Remove the rubber cap on the SMA connector before installing the antenna.
2. Align the antenna with the SMA connector located on the rear side of the EAC Mini and fasten it as shown on the picture.
3. Adjust the position of external antenna for better signal.

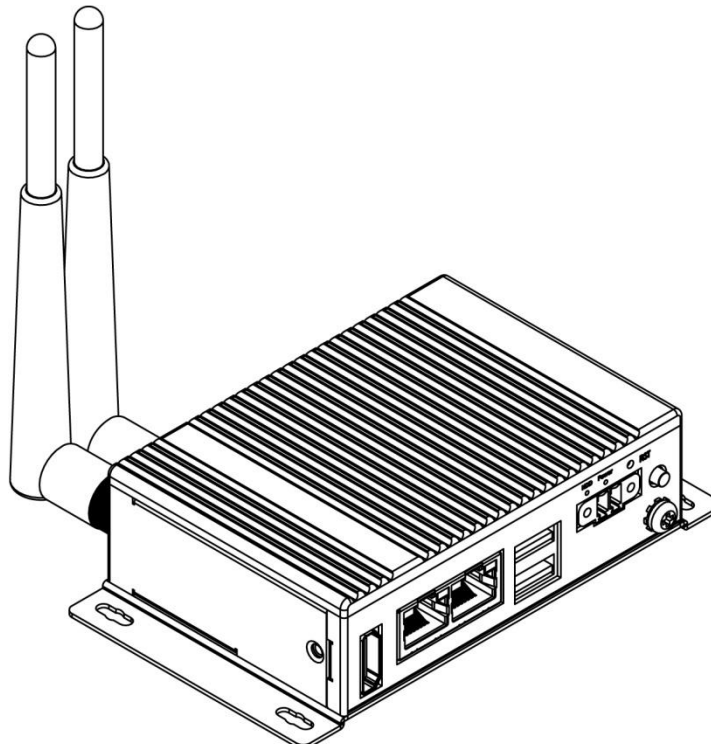



## **2.2.3 Expansion Module Installation**

Notice that expansion module is an optional feature of the EAC Mini EACIL20.

*To install expansion module:*

1. Unscrew the three screws on the bottom cover.
2. Remove the I/O module from the 2<sup>nd</sup> layer. Attach module to the 1<sup>st</sup> layer and fasten five screws inside.
3. Insert the I/O module and fasten two screws inside.
4. Screw back the bottom cover and fasten screws in front to secure I/O module.

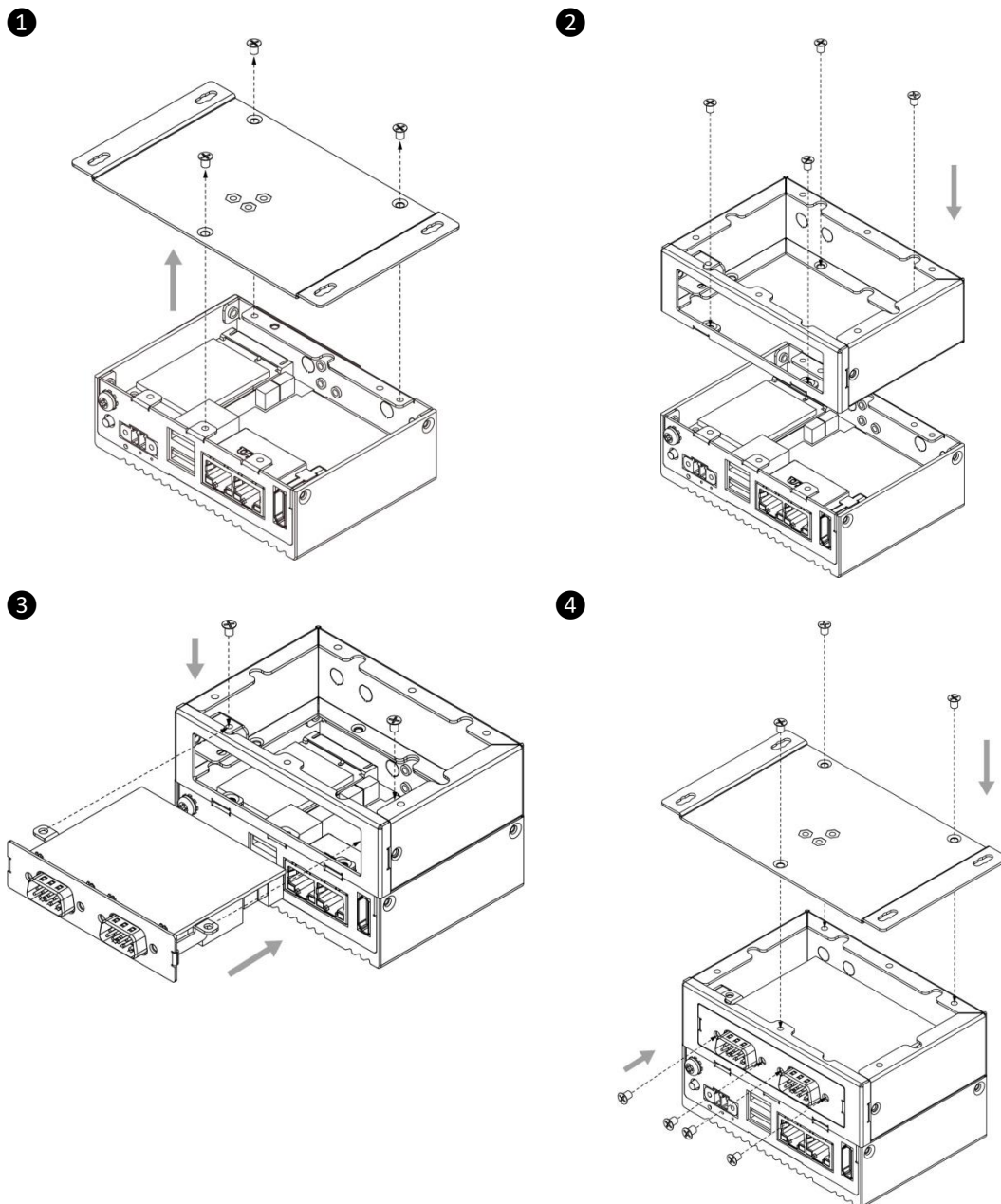

## 2.3 Connecting the Power

The DC power supply connector of the EAC Mini IoT Gateway is on the front panel. The DC power input for the EAC Mini allows a voltage input range from 9 V DC to 30 V DC.



### **WARNING!**

Ensure voltage and polarity is compliant with the DC input. Improper input voltage or polarity can cause system damage.

### **2.3.1 Connecting the Power**

Connect EAC Mini to 9-36V DC. The power source can either be from a power adapter or an in-house power source. Front power LED indicator indicates the power status of the device.

### **2.3.2 Chassis Grounding**

EAC Mini provides EMI protection and a stable grounding base. Use chassis grounding point located on the front.

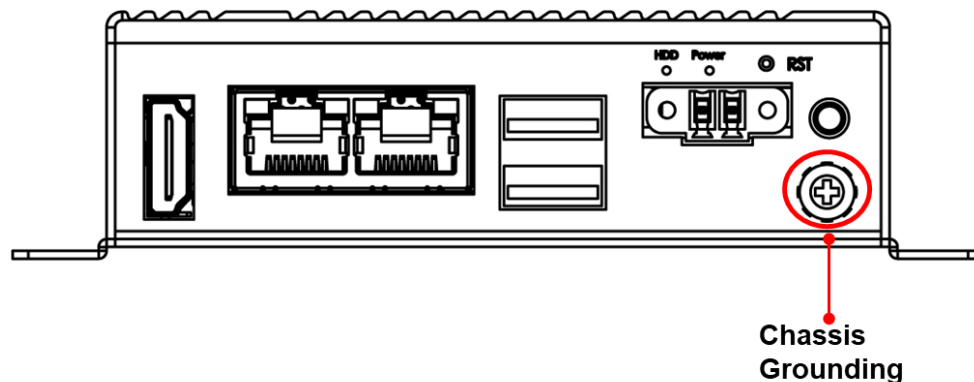

## **MOUNTING**

This chapter provides step-by-step mounting guide for all available mounting options.



## CHAPTER 3: MOUNTING

The EAC Mini supports five types of mounting: wall and desk mounting by default, and optional VESA, DIN-rail, Pole mounting solutions. You can purchase mounting kit from Winmate as an optional accessory.

### 3.1 Wall/ Desk Mount

L-shape mounting brackets for wall/ desk mounting are supplied with the EAC Mini.

*Mounting Instruction:*

1. Fasten screws to secure L-shape mounting brackets to the EAC Mini
2. Place the EAC Mini on the fixture (ex. table) and fasten screws to secure the unit to the fixture.

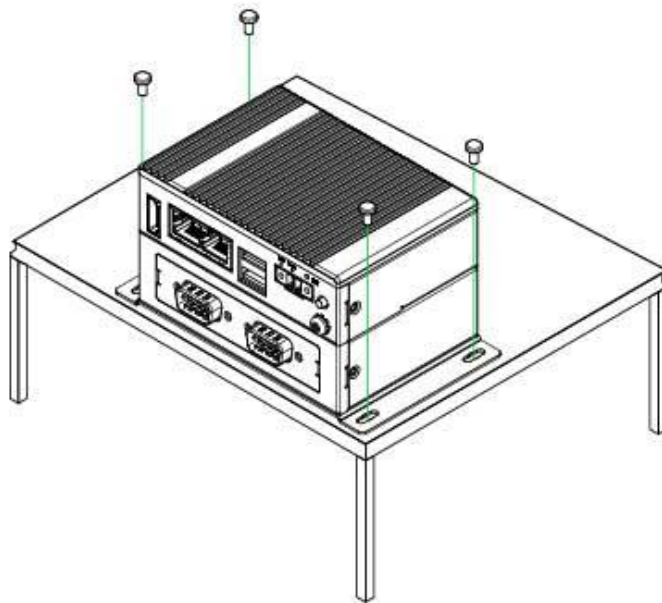

### 3.2 DIN-Rail Mount

You can purchase DIN-Rail mounting kit from Winmate as an optional accessory.

DIN-Rail Mounting Kit:  
Part Number: 821118551400

*Mounting Instruction:*

1. Fasten screws to secure DIN-rail mounting bracket to the EAC Mini.
2. Place the EAC Mini with the DIN-Rail bracket on the DIN-Rail.

1

Rear Side

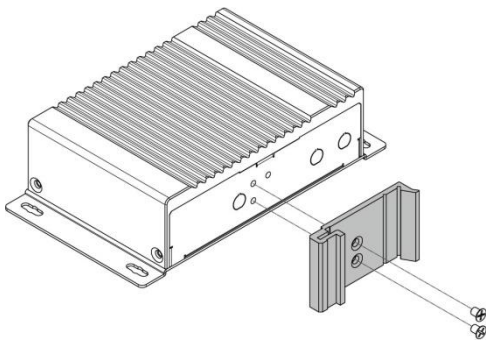

2

Rear Side

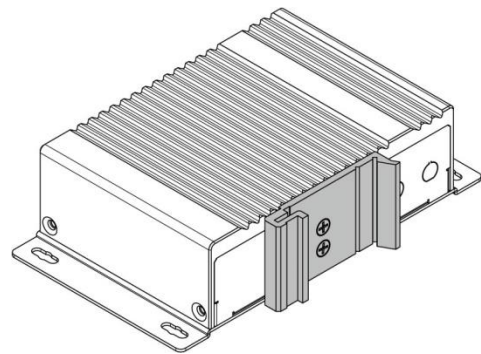

1

Bottom Side

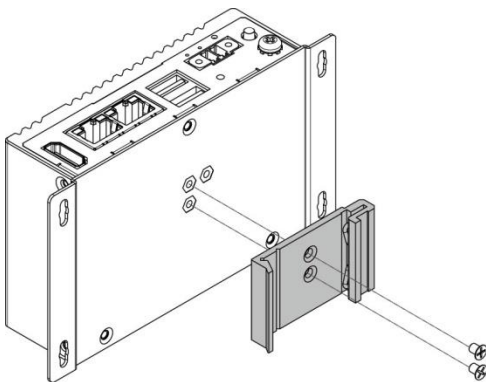

2

Bottom Side

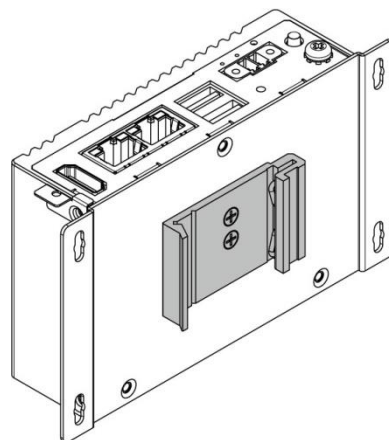

### 3.3 VESA Mount

You can purchase VESA mounting kit from Winmate as an optional accessory.

VESA Mounting Kit

Part Number: 821118561001

*Mounting Instruction:*

1. Mark the location of the screw holes on the fixture (ex. wall).
2. Align the VESA mounting bracket with the screw location.
3. Place the EAC Mini on the VESA mounting bracket and fasten screws to secure and the EAC Mini to the fixture.

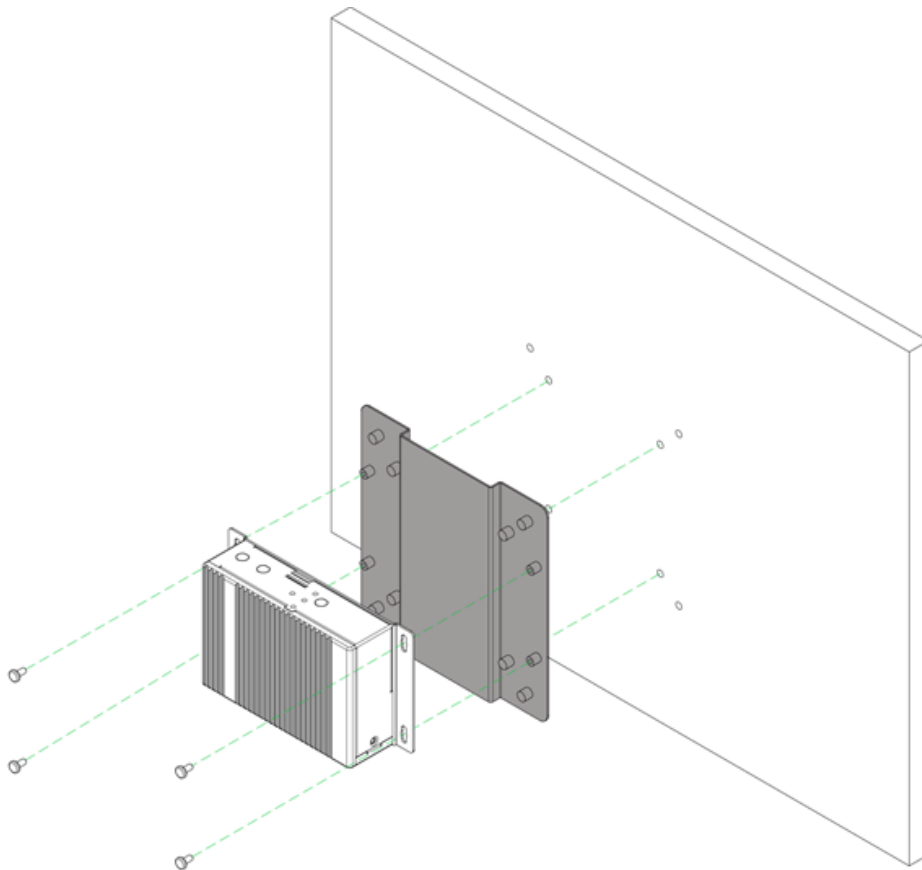

## **INSYDE UEFI BIOS SETUP**

# 4

BIOS Setup Utility is a program for configuration basic Input / Output system settings of the computer for optimum use. This chapter provides information on how to use BIOS setup, its functions and menu.

## CHAPTER 4: INSYDE UEFI BIOS SETUP

BIOS Setup Utility is a program for configuration basic Input / Output system settings of the computer for optimum use. This chapter provides information on how to use BIOS setup, its functions and menu.

### 4.1 How and When to Use BIOS Setup

To enter the BIOS setup, you need to connect an external USB keyboard, external monitor and press Del key when the prompt appears on the screen during start up. The prompt screen shows only few seconds so need press Del key quickly.

**IMPORTANT:**

Updated BIOS version may be published after the manual released. Check the latest version of BIOS on the website.

You may need to run BIOS setup utility for reasons listed below:

1. Error message on screen indicates to check BIOS setup
2. Restoring the factory default settings.
3. Modifying the specific hardware specifications
4. Necessity to optimize specifications

#### BIOS Navigation Keys

The following keys are enabled during POST:

Key	Function
Del	Enters the BIOS setup menu.
ESC	Pressing the [ESC] key stops the POST. Press any other key to resume the POST.



The following Keys can be used after entering the BIOS Setup.

Key	Function
F1	Help
Esc	Exit
Cursor ↑/↓	Select item
Cursor ←/→	Select item
F5/F6	Change values
Enter	Select submenu
F9	Setup defaults
F10	Save and Exit

**NOTE:**

You can press the F1, F2, F3, F4, -/+, and Esc keys by connecting a USB keyboard to your computer.

For items marked ► press <Enter> for more options.

## 4.2 BIOS Functions

### 4.2.1 Main Menu

The Main menu displays the basic information about your system including BIOS version, processor RC version, system language, time, and date.

When you enter BIOS setup, the first menu that appears on the screen is the main menu. It contains the system information including BIOS version, processor RC version, system language, time, and date.

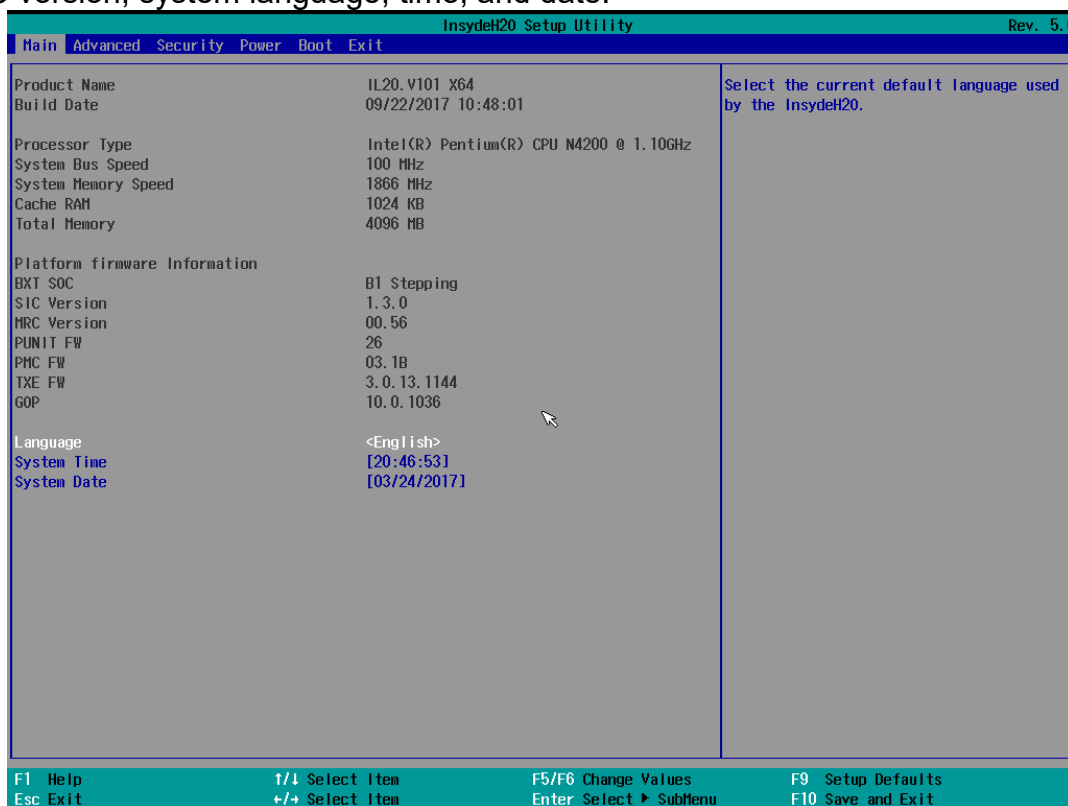

BIOS Setting	Description	Setting Option	Effect
<b>Language</b>	Displays the system language. [English] is set up by default.	Adjustment of the language	Set the language in other language. The language in this device is English.
<b>System Time</b>	This is current time setting. The time is maintained by the battery when the device is turned off.	Time changes.	The time in the format: [hh/mm/ss]
<b>System Date</b>	This is current date setting	Date changes.	Set the date in the format [mm/dd/yyyy]

## 4.2.2 Advanced Settings

Select the Advanced Tab from the setup menu to enter the advanced BIOS setup screen. You can select any of the items on the left frame of the screen to go to the sub menu for the item, such as CPU Configuration. You can use the <Arrow> keys enter all advanced BIOS setup options. The advanced BIOS setup menu is shown below. The submenus described on the following pages.



### CAUTION

Handle advanced BIOS settings page with caution. Any changes can affect the operation of your computer.

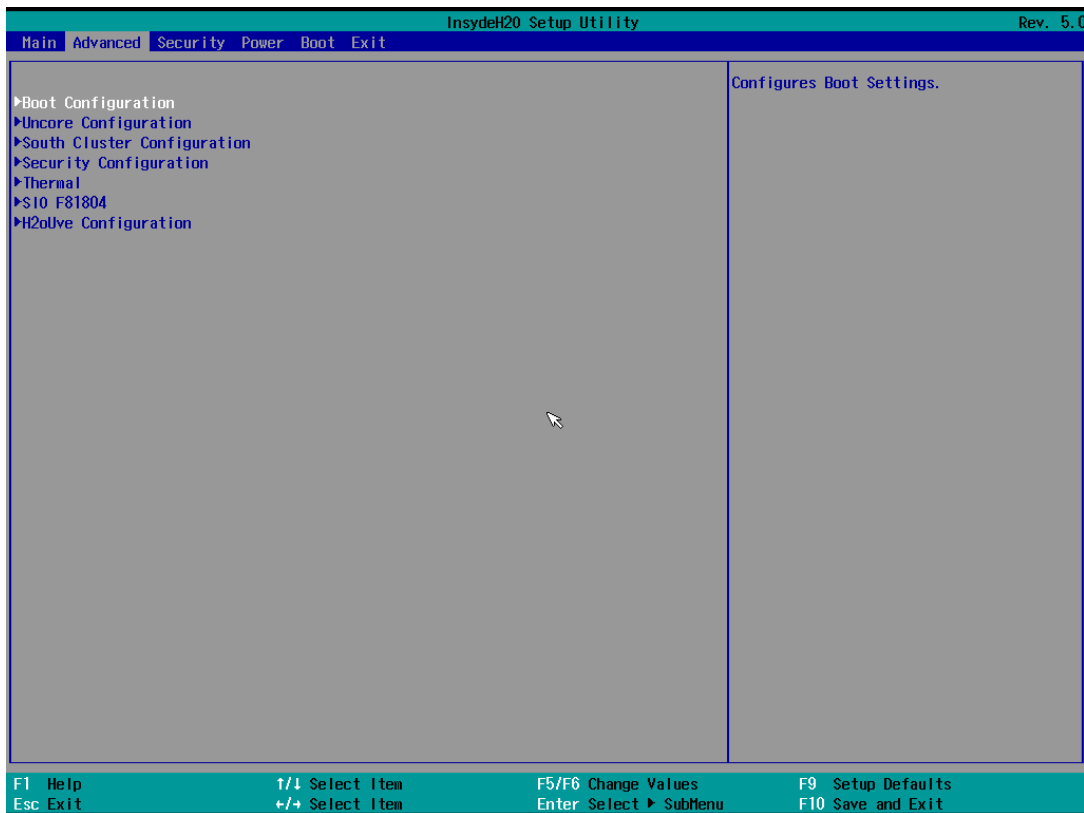

BIOS Setting	Description	Setting Option	Effect
<b>Boot Configuration</b>	Configures Boot parameters	Enter	Opens submenu
<b>Uncore Configuration</b>	Configures Uncore parameters	Enter	Opens submenu
<b>South Cluster Configuration</b>	Configures South Cluster parameters	Enter	Opens submenu
<b>Security Configuration</b>	Configures Security parameters	Enter	Opens submenu
<b>Thermal</b>	Configures Thermal parameters	Enter	Opens submenu
<b>S10 F81804</b>	Configures S10 F81804 parameters	Enter	Opens submenu
<b>H2oUvo Configuration</b>	Configures H2oUvo parameters	Enter	Opens submenu

### 4.2.2.1 Boot Configuration

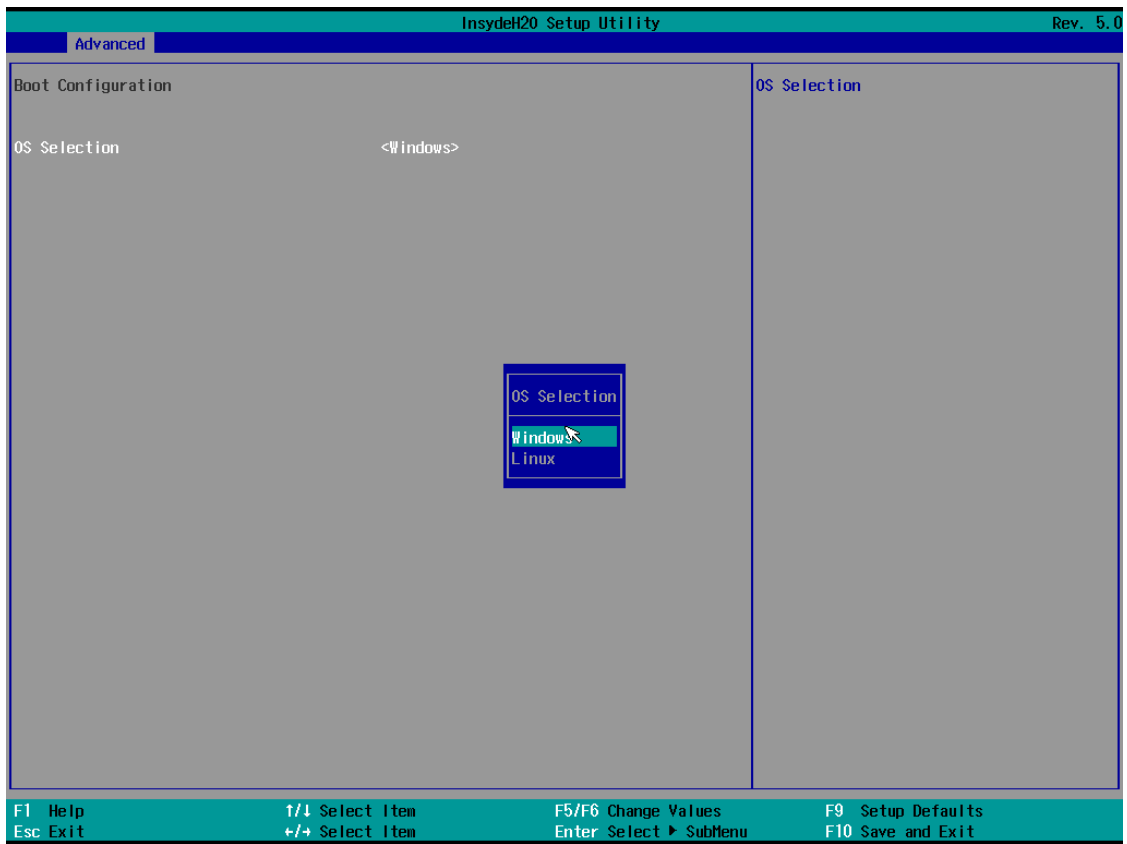

BIOS Setting	Description	Setting Option	Effect
OS Selection	Select the OS of your computer.	Windows/ Linux	Select OS

### 4.2.2.2 GOP and IGD Configuration

InsydeH20 Setup Utility		Rev. 5.0								
Advanced										
GOP Configuration GOP Driver <Enabled>		Enable GOP Driver will unload VBIOS; Disable it will load VBIOS								
IGD Configuration Integrated Graphics Device <Enabled> Primary Display <Auto> RC6(Render Standby) <Enabled> GTT Size <8MB> Aperture Size <256MB> DVMT Pre-Allocated <64M> DVMT Total Gfx Mem <256M> Cd Clock Frequency <624 MHz> GT PM Support <Enabled> PAVP Enable <Enabled>										
<table border="0"> <tr> <td>F1 Help</td> <td>↑/↓ Select Item</td> <td>F5/F6 Change Values</td> <td>F9 Setup Defaults</td> </tr> <tr> <td>Esc Exit</td> <td>+/- Select Item</td> <td>Enter Select SubMenu</td> <td>F10 Save and Exit</td> </tr> </table>			F1 Help	↑/↓ Select Item	F5/F6 Change Values	F9 Setup Defaults	Esc Exit	+/- Select Item	Enter Select SubMenu	F10 Save and Exit
F1 Help	↑/↓ Select Item	F5/F6 Change Values	F9 Setup Defaults							
Esc Exit	+/- Select Item	Enter Select SubMenu	F10 Save and Exit							

BIOS Setting	Description	Setting Option	Effect
<b>GOP Configuration</b>			
GOP Driver	Use this item to enable or disable GOP Driver	Enabled	Enable GOP Driver will unload VBIOS
		Disabled	Disable It will load VBIOS
<b>IGD Configuration</b>			
Integrated Graphics Driver	Use this item to enable or disable Integrated Graphics Driver	Enabled/ Disabled	Enables or disables Integrated Graphics Driver
Primary Display	Use this item to select Primary Display	Auto/ IGD/ PCIe	Select which of IGD/PCI Graphics device should be primary display
RC6 (Render Standby)	Use this item to enable or disable Render Standby <i>* This item will be read only if SOix enabled</i>	Enabled/ Disabled	Check to enable Render Standby support, PC6 should be enabled if SOix is enabled.
GTT Size	Use this item to select GTT Size	2MB/ 4MB/ 8MB	Select the GTT Size
Aperture Size	Use this item to select Aperture Size	128MB/ 256MB/ 512MB	Select the Aperture Size
DVMT Pre-Allocated	Use this item to select DVMT Pre-Allocated	64M~512M	Select DVMT 5.0 Pre-Allocated (Fixed) Graphics memory size used by Internal Graphics Device.
DVMT Total Gfx Mem	Use this item to select DVMT Total Gfx Mem	128MB/ 256MB/ MAX	Select DVMT 5.0 Graphics memory size used by Internal Graphics Device.
CD Clock Frequency	Use this item to select CD Clock Frequency	144MHz/ 288MHz/ 384MHz/ 576MHz/ 624MHz	Select the highest CD Clock Frequency supported by the platform
GT PM Support	Use this item to enable or disable GT PM Support	Enabled/ Disabled	Enable/ Disable GT PM Support
PAVP Enable	Use this item to enable or disable PAVP	Enabled/ Disabled	Enable/ Disable PAVP

### 4.2.2.3 Advanced Configuration

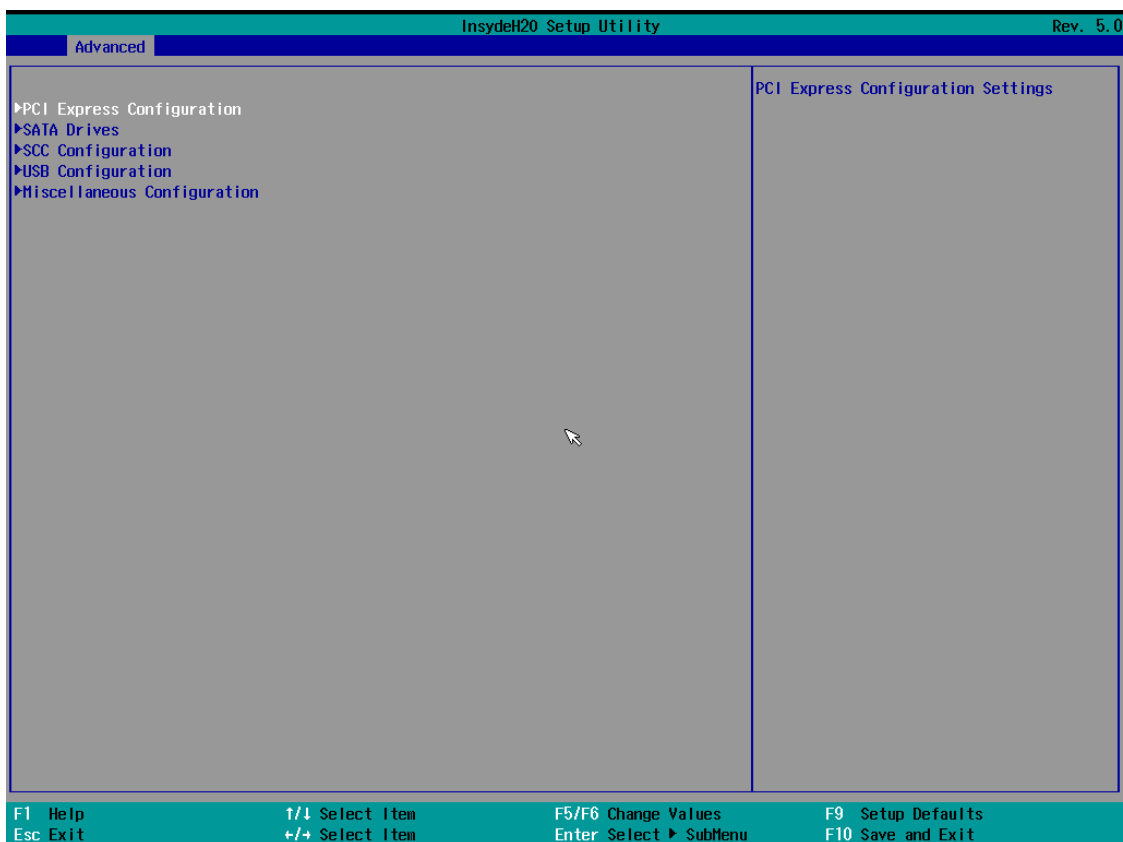

BIOS Setting	Description	Setting Option	Effect
PCI Express Configuration	Use this item to select PCI Express parameters	Enter	Opens submenu
SATA Drives	Use this item to change SATA Drives parameters	Enter	Opens submenu
SCC Configuration	Use this item to change SCC Configuration	Enter	Opens submenu
USB Configuration	Use this item to change USB Configuration	Enter	Opens submenu
Miscellaneous Configuration	Use this item to change USB Configuration	Enter	Opens submenu

### 4.2.2.3.1 PCI Express Configuration

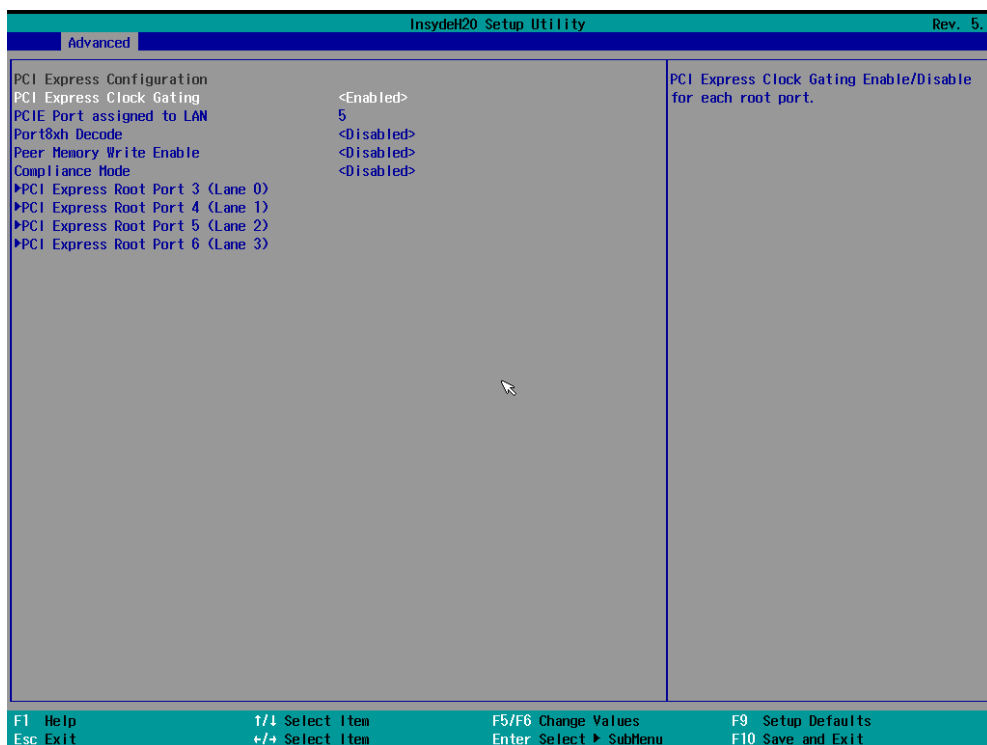

BIOS Setting	Description	Setting Option	Effect
PCI Express Clock Gating	Use this item to select PCI Express Clock Gating parameters	Enabled/ Disabled	PCI Express Clock Gating enable/ disable for each root port
PCIe Port Assigned to LAN	Use this item to select which PCIe Port Assigned to LAN	5	Select which PCIe port assigned to LAN
Port 8xh Decode	Use this item to select Port 8xh Decode parameters	Enabled/ Disabled	Enable/ Disable PCI Express Port 8xh Decode
Peer Memory Write Enable	Use this item to select Peer Memory Write parameters	Enabled/ Disabled	Enable/ Disable Peer Memory Write
Compliance Mode	Use this item to select Compliance Mode parameters	Enabled/ Disabled	Enable/ Disable Compliance Mode
PCI Express Root Port 3 (LANE0)	Control the PCI Express Root Port 3 (Lane 0)	Enter	Opens submenu
PCI Express Root Port 4 (Lane 1)	Control the PCI Express Root Port 4 (Lane 1) parameters	Enter	Opens submenu
PCI Express Root Port 5 (Lane 2)	Control the PCI Express Root Port 5 (Lane 2) parameters	Enter	Opens submenu
PCI Express Root Port 6 (Lane 3)	Control the PCI Express Root Port 6 (Lane 3) parameters	Enter	Opens submenu



*PCI Express Root Port*

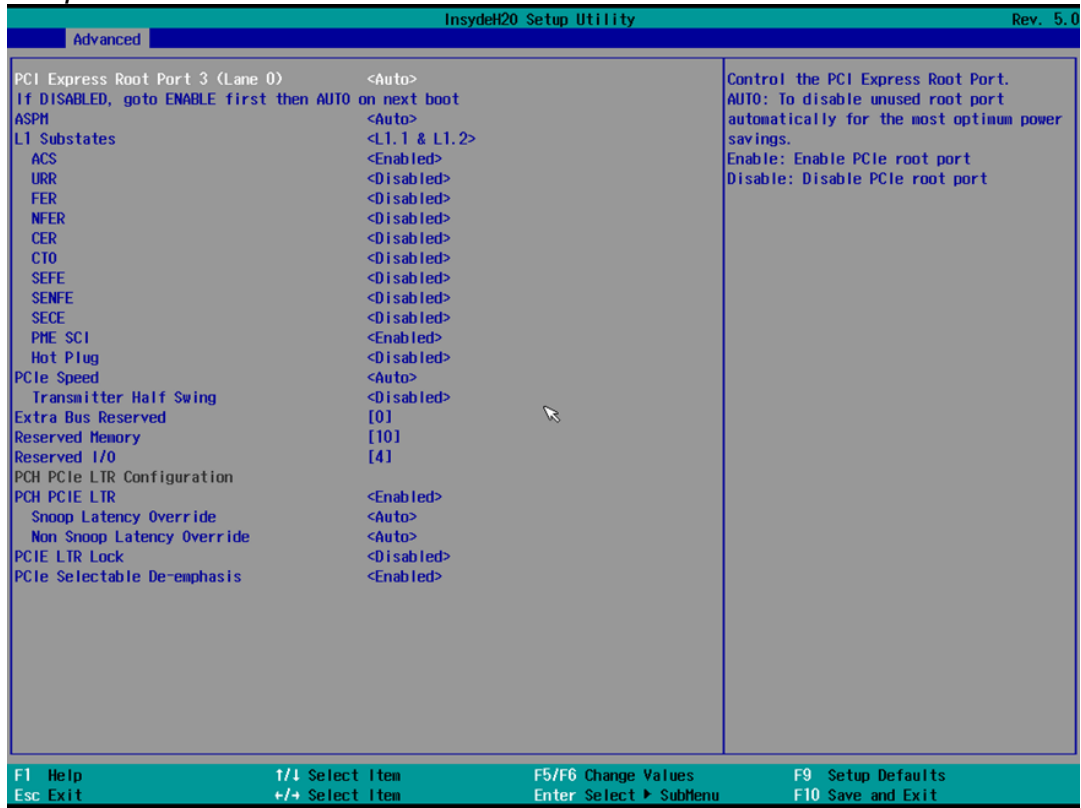

BIOS Setting	Description	Setting Option	Effect
ASPM	PCI Express Active State Power Management setting	Disabled/ L0s/ L1/ L0sL1/ Auto	Set the parameters of ASPM
L1 Substates	PCI Express L1 Substate settings	Disabled/ L1.1/ L1.2/ L1.1 &L1.2	Set the parameters of L1 Substate
ACS	Configure Access Control Services Extended Capability	Disabled/ Enabled	Enable/ Disable ACS
URR	Configure PCI Express Unsupported Request Reporting	Disabled/ Enabled	Enable/ Disable URR
FER	Configure PCI Express Device Fatal Error Reporting	Disabled/ Enabled	Enable/ Disable FER
NFER	Configure PCI Express Device Non-Fatal Error Reporting	Disabled/ Enabled	Enable/ Disable NFER
CER	Configure PCI Express Device Correctable Error Reporting	Disabled/ Enabled	Enable/ Disable CER
CTO	Configure PCI Express Complation Timer TO	Disabled/ Enabled	Enable/ Disable CTO
SEFE	Configure Root PCI Express System Error on Fatal Error	Disabled/ Enabled	Enable/ Disable SEFE
SENFEE	Configure Root PCI Express System Error on Non-Fatal Error	Disabled/ Enabled	Enable/ Disable SENFEE
SECE	Configure Root PCI Express System Error on Correctable Error	Disabled/ Enabled	Enable/ Disable SECE
PMI SCI	Configure PCI Express PMI SCI	Disabled/ Enabled	Enable/ Disable PMI SCI
Hot Plug	Configure PCI Express Hot Plug settings	Disabled/ Enabled	Enable/ Disable Hot Plug
PCI Speed	Configure PCI Speed	Auto/ Gen 1/ Gen2	Set PCI Speed parameters
Transmitter Half Swing	Configure Transmitter Half Swing	Disabled/ Enabled	Enable/ Disable Transmitter Half Swing
PCH PCIE LTR	Configure PCH PCIE Latency Reporting settings	Disabled/ Enabled	Enable/ Disable PCH PCIE LTR
Snoop Latency Override	Snoop Latency Override for PCH PCIE	Disabled	Disable Override
		Manual	Manually enter override values
		Auto (Default)	Maintain default BIOS flow
Non Snoop Latency Override	Non Snoop Latency Override for PCH PCIE	Disabled	Disable Override
		Manual	Manually enter override values
		Auto (Default)	Maintain default BIOS flow
PCIE LTR Lock	PCIE LTR Configuration Lock	Disabled/ Enabled	Enable/ Disable PCIE LTR Lock
PCIE Selectable De-emphasis	When the link is operating at 5.0 GT/s speed, this bit select the level of de-emphasis for an Upstream component 1d -3.5dB, 0b -6dB	Disabled/ Enabled	Enable/ Disable PCIE Selectable De-emphasis

### 4.2.2.4 SATA Drives

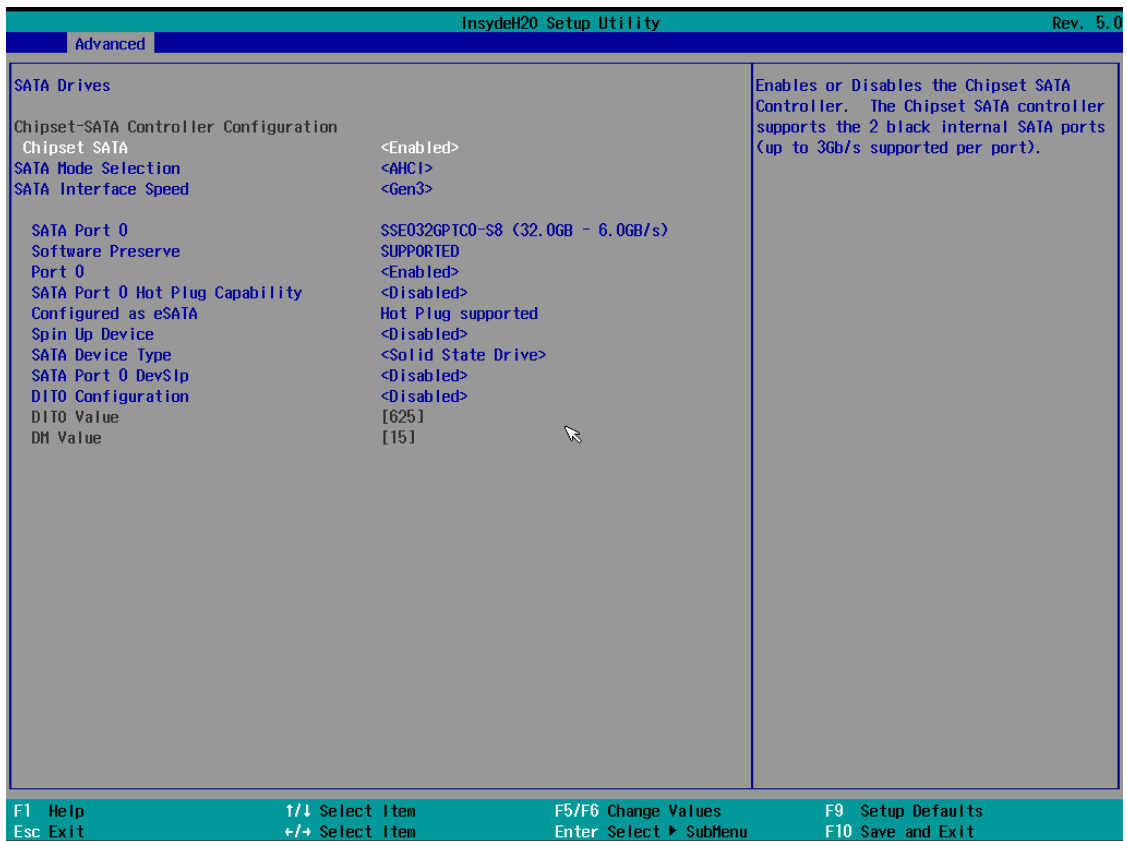

BIOS Setting	Description	Setting Option	Effect
Chipset-SATA Controller Configuration	The Chipset SATA controller supports the 2 black Internal SATA ports (up to 3 GBb/s supported per port)	Enabled/ Disabled	Enables/ Disables the Chipset-SATA Controller
SATA Mode Selection	Determines how SATA controller(s) operate	AHCI	Select SATA Mode
SATA Interface Speed	Select SATA interface speed, CHV A1 always with Gen1 selected	Gen1/ Gen2/ Gen3	Select SATA Interface Speed
Port 0	Enable or Disable SATA Port	Enabled/ Disabled	Enable/ Disable SATA Port
SATA Port 0 Hot Plug Capability	Enable or Disable SATA Port 0 Hot Plug Capability	Enabled/ Disabled	If enabled, SATA port will be reported as Hot Plug capable.
Spin Up Device	Configure Spin Up Device settings	Enabled/ Disabled	If enabled for any of ports Staggered Spin Up will be performed and only the drives which have this option enabled will spin up at boot. Otherwise all drives spin up at boot.
SATA Device Type	Identify the SATA port is connected to Hard Disk Drive or Solid State Drive	Hard Disk Drive/ Solid State Drive	SATA Device connected to HDD or SSD
SATA Port 0 DevSlp	Configure SATA Port 0 DevSlp settings	Enabled/ Disabled	Enable/ Disable SATA Port 0 DevSlp. <i>*Board rework for LP needed before enable</i>
DITO Configuration	Configure DITO settings	Enabled/ Disabled	Enable/ Disable DITO Configuration

### 4.2.2.5 SCC Configuration

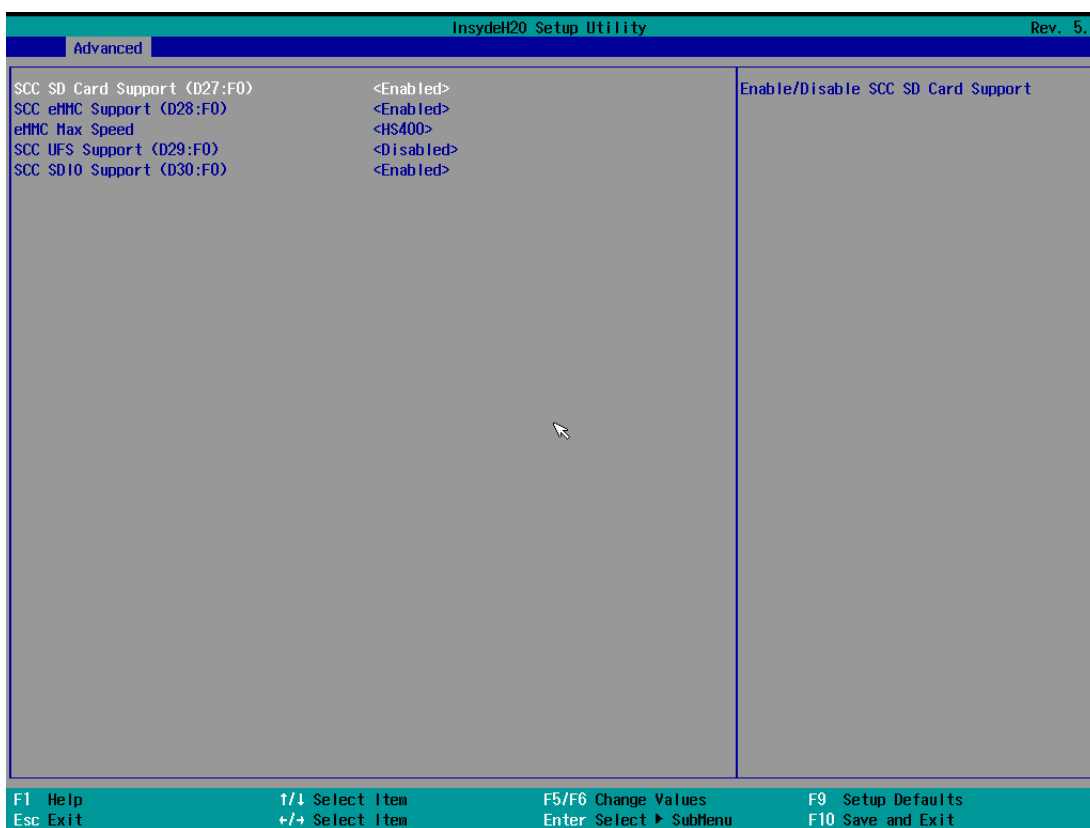

BIOS Setting	Description	Setting Option	Effect
SCC SD Card Support (D27:F0)	Configure SCC SD Card Support settings	Enabled/ Disabled	Enable/ Disable SCC SD Card Support
SCC eMMC Support (D28:F0)	Configure SCC eMMC Support settings	Enabled/ Disabled	Enable/ Disable SCC eMMC Support
eMMC Max Speed	Select the eMMC speed allowed	HS400/ HS200/ DDR50	Select the eMMC speed
SCC UFC Support (D29:F0)	Configure SCC UFC Support settings	Enabled/ Disabled	Enable/ Disable SCC UFC Support
SCC SDIO Support (D30:F0)	Configure SCC SDIO Support Support settings	Enabled/ Disabled	Enable/ Disable SCC SDIO Support

**4.2.2.6 USB/ XHCI/ XDCI Configuration**

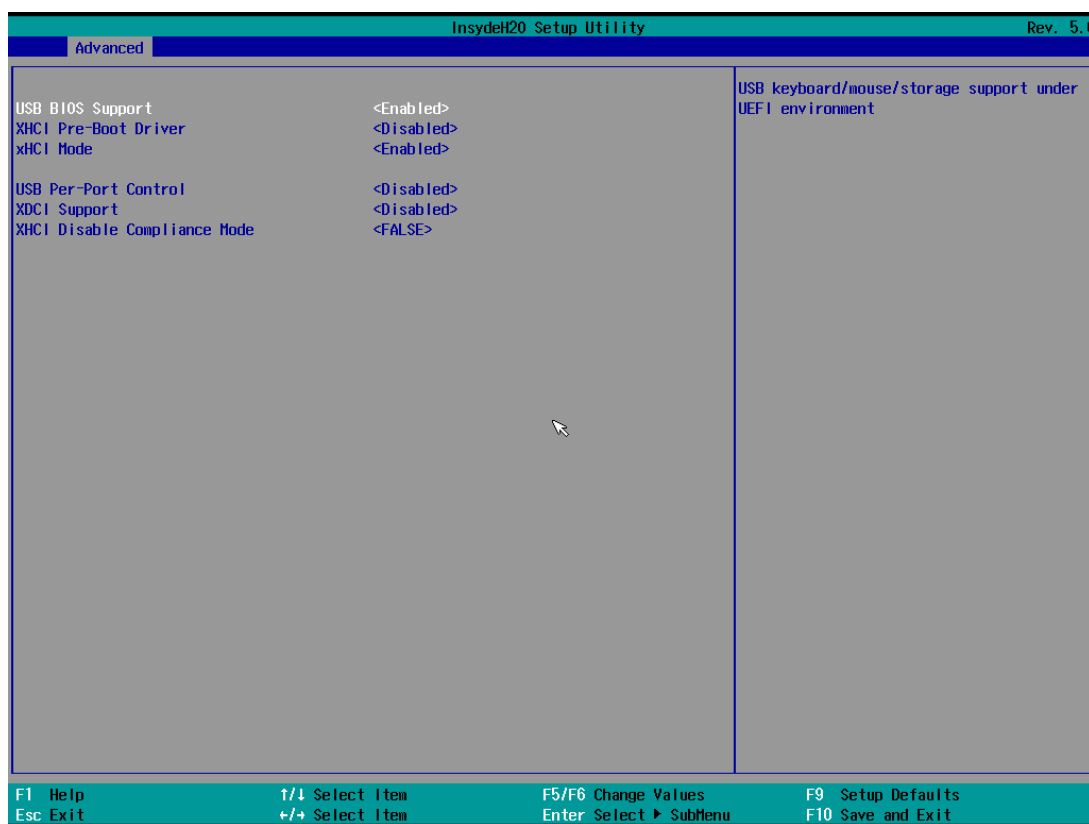

BIOS Setting	Description	Setting Option	Effect
USB BIOS Support	Configure USB BIOS Support settings	Enabled/ Disabled	USB/ keyboard/ mouse/ storage support under UEFI environment
XHCI Pre-boot Driver	Configure XHCI Pre-boot Driver settings	Enabled/ Disabled	Enable/ Disable XHCI Pre-boot support
XHCI Mode	Configure XHCI Mode settings	Enabled/ Disabled	Once disabled, XHCI would be function disabled, none of the USB devices are detectable and usable during boot and in OS. <b>Do not disable it unless for debug purpose.</b>
USB Per-Port Control	Configure USB Per-Port Control settings	Enabled/ Disabled	Control each of the USB ports (0~3) enable/disable
XDCI Support	Configure XDCI Support settings	Enabled/ Disabled	Enable/ Disable XDCI Support
XDCI Disable Compliance Mode	Configure XDCI Disable Compliance Mode settings	FALSE (Default)/ TRUE	Option to disable XHCI Link Compliance Mode. Default is FALSE to not disable Compliance Mode. Set TRUE to disable Compliance Mode.

### 4.2.2.7 Miscellenaous Configuration

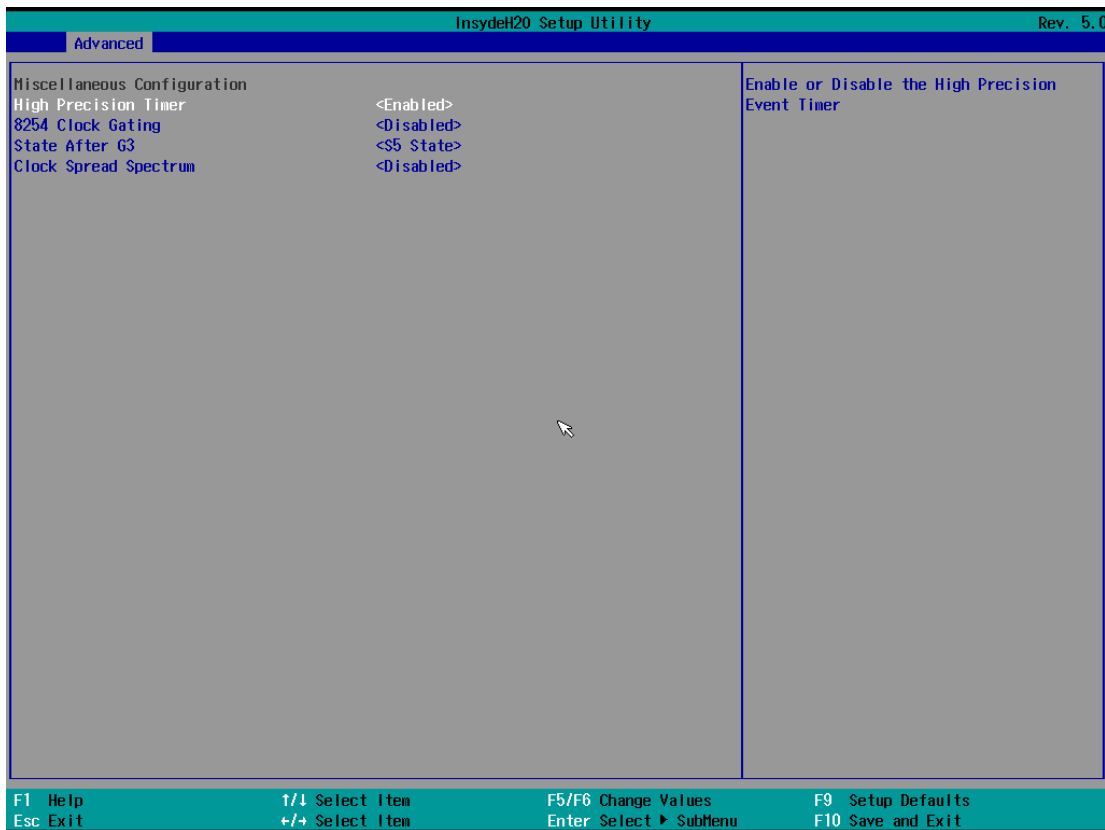

BIOS Setting	Description	Setting Option	Effect
High Precious Timer	Configure High Precious Timer t settings	Enadbled/ Disabled	Enadble/ Disable XDCI High Precious Event Timer
8254 Clock Gating	Configure 8254 Clock Gating settings	Enadbled/ Disabled	Enadble/ Disable 8254 Clock Gating
State After G3	Specify which state to go to when power is re-applied after a power failure (G3 State)	S0 State	System will boot directly as soon as power applied
		S5 State	System keeps in power off state until power buttom is pressed
Clock Spread Spectrum	Configure Clock Spread Spectrum settings	Enadbled/ Disabled	Enadble/ Disable Clock Spread Spectrum feature

### 4.2.2.8 TXE and TPM Configuration

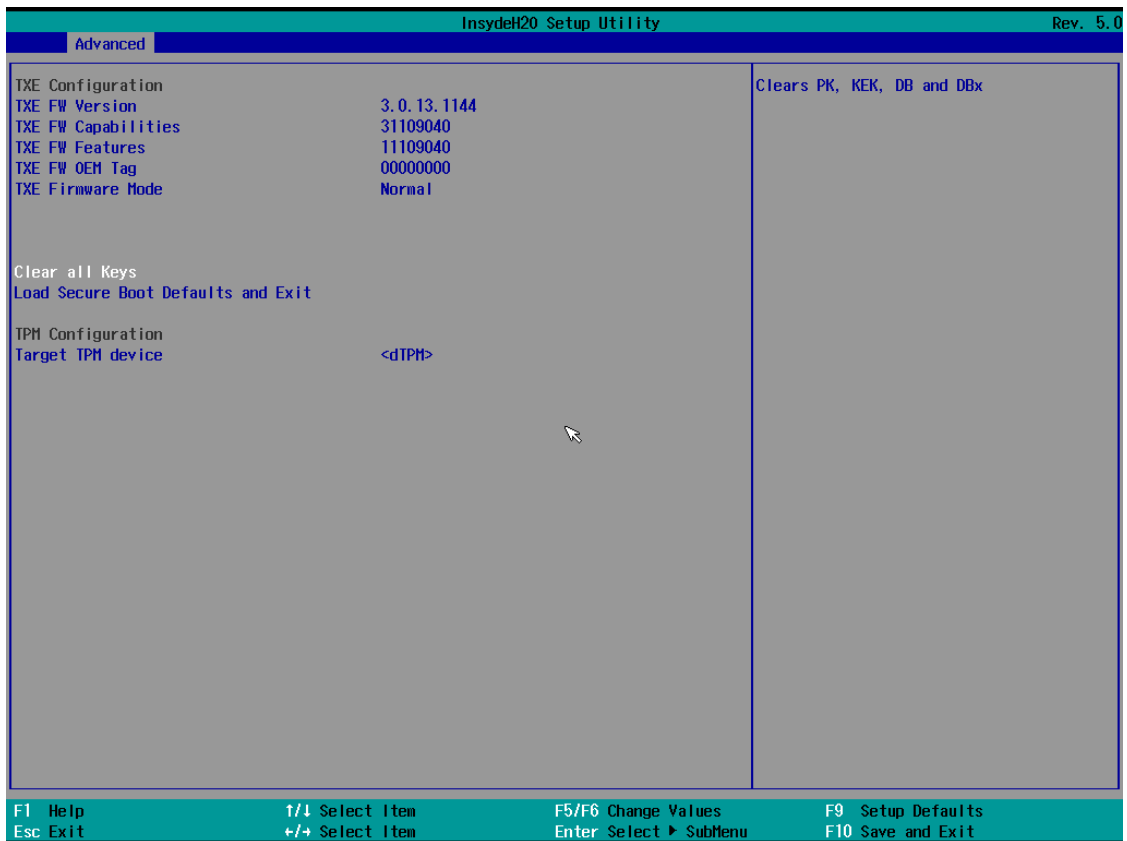

BIOS Setting	Description	Setting Option	Effect
Target TPM device	Configure Target TPM device settings	fTPM/ dTPM	Select fTPM or dTPM



**4.2.2.9 Thermal Configuration Parameters**

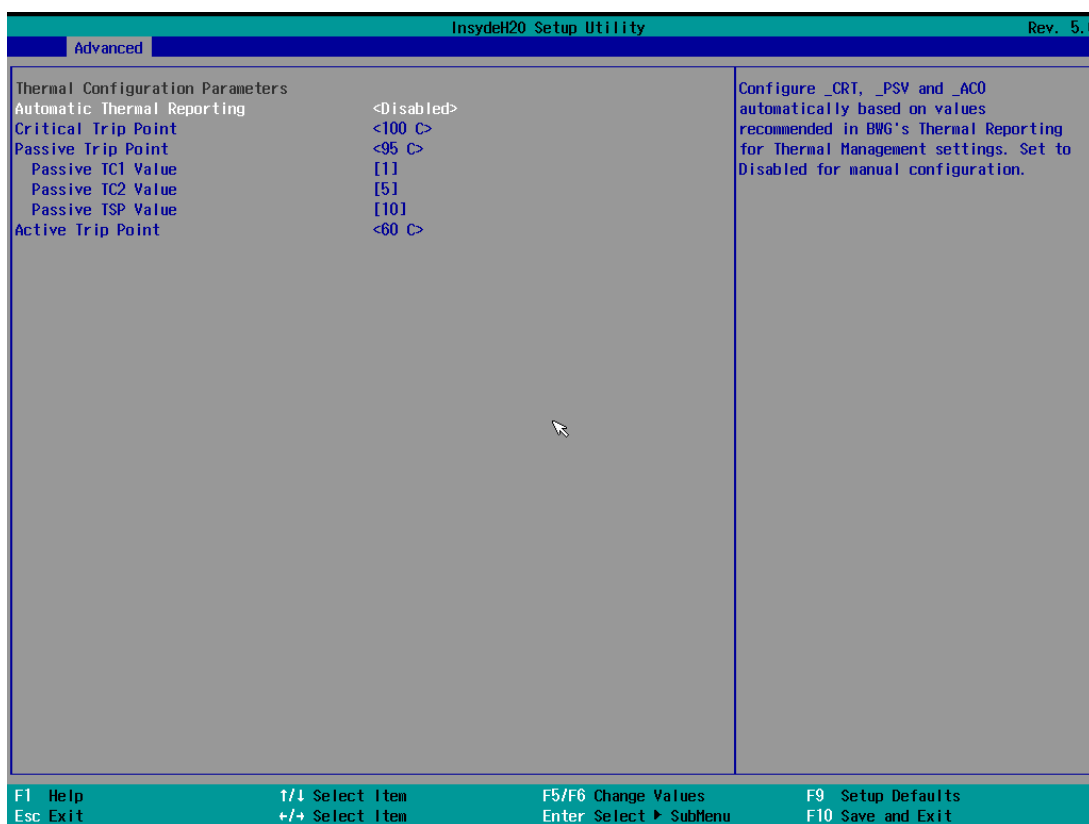

BIOS Setting	Description	Setting Option	Effect
Automatic Thermal Reporting	Configure _CTR, _PSV, and _ACO automatically based on values recommended in BWG's Thermal Reporting for Thermal Management settings	Enabled/ Disabled	Set to Disabled for manual configuration
Critical Trip Point	This value controls the temperature of the ACPI Critical Trip Point – the point in which the OS will shut the system off.	Disabled/ 15C~103C	Select the value <b>NOTE: 100C is the Plan of Record (POR) for all Intel Mobile Processors</b>
Passive Trip Point	This value controls the temperature of the ACPI Passive Trip Point - the point in which the OS will begin throttling the processor	Disabled/ 15C~103C	Select the value
Active Trip Point	This value controls the temperature of the ACPI Active Trip Point - the point in which OS will turn the fan on.	Disabled/ 15C~103C	Select the value

**4.2.2.10 WDT Configuration**

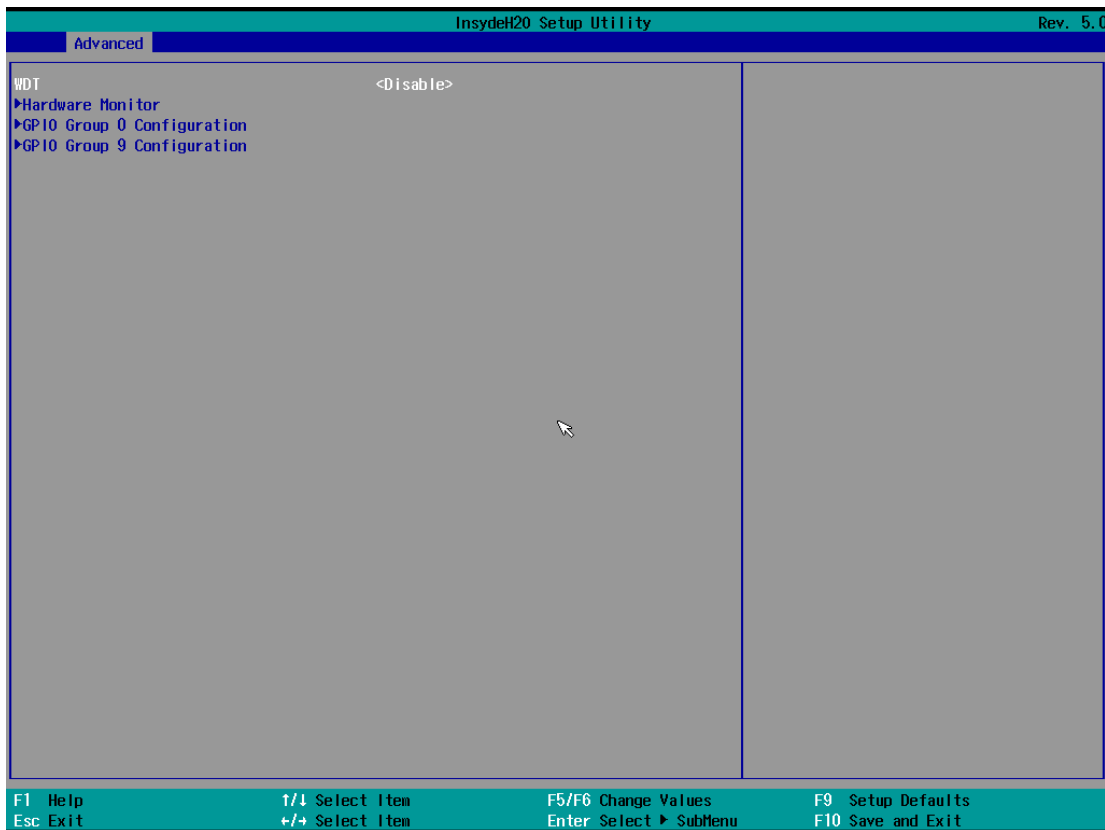

BIOS Setting	Description	Setting Option	Effect
WDT	Configure WDT settings	Enabled/ Disabled	Enable/Disable WDT
Hardware Monitor	Check Hardware Monitor settings	Press Enter	Open sub-menu
GPIO Group 0 Configuration	Check GPIO Group 0 Configuration	Press Enter	Open sub-menu
GPIO Group 9 Configuration	Check GPIO Group 9 Configuration	Press Enter	Open sub-menu

Hardware Monitor



GPIO Group 0 Configuration

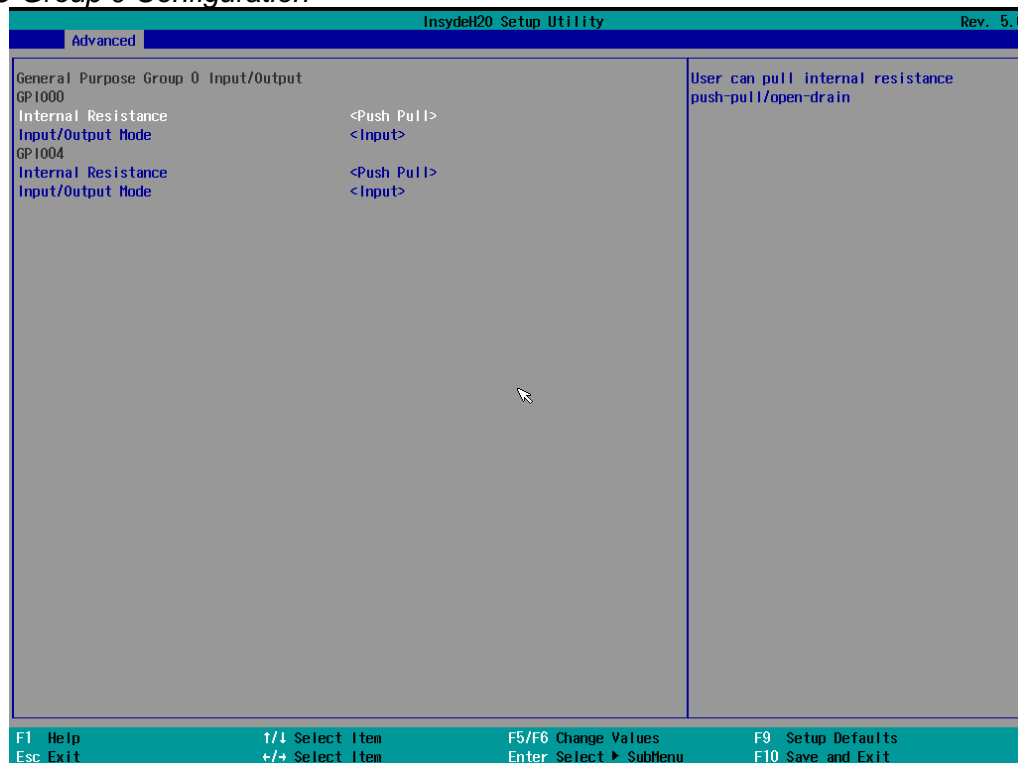

BIOS Setting	Description	Setting Option	Effect
Internal Resistance	User can pull internal resistance push-pull/open-drain	Push Pull/ Open Drain	Set Push Pull or Open Drain
Input/ Output Mode	Set the GPIO is input or output	Input/ Output	Set the GPIO is input or output

**4.2.2.11 H2oUve Setup**

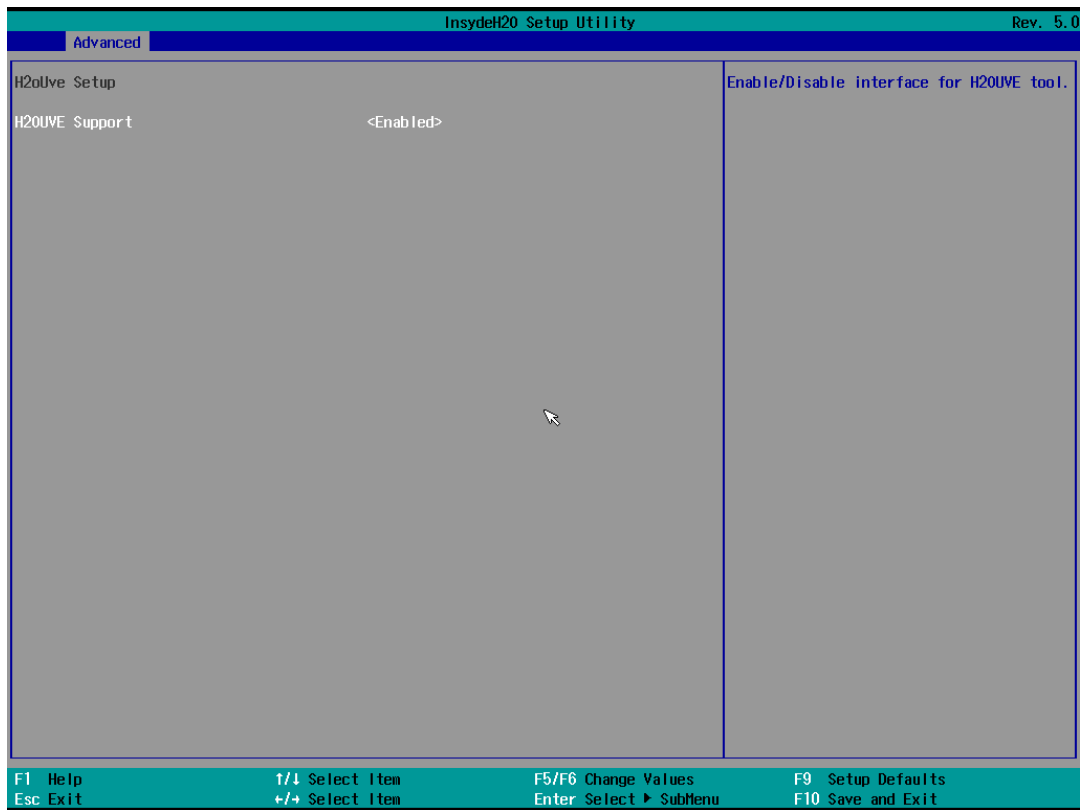

BIOS Setting	Description	Setting Option	Effect
H2oUve Support	Enable/ Disable Interface for H2oUve tool	Enabled/ Disabled	Enable/ Disable H2oUve Support

## 4.2.4 Security Menu

This section allows to configure and improve system, and set up some system features according to your preferences.

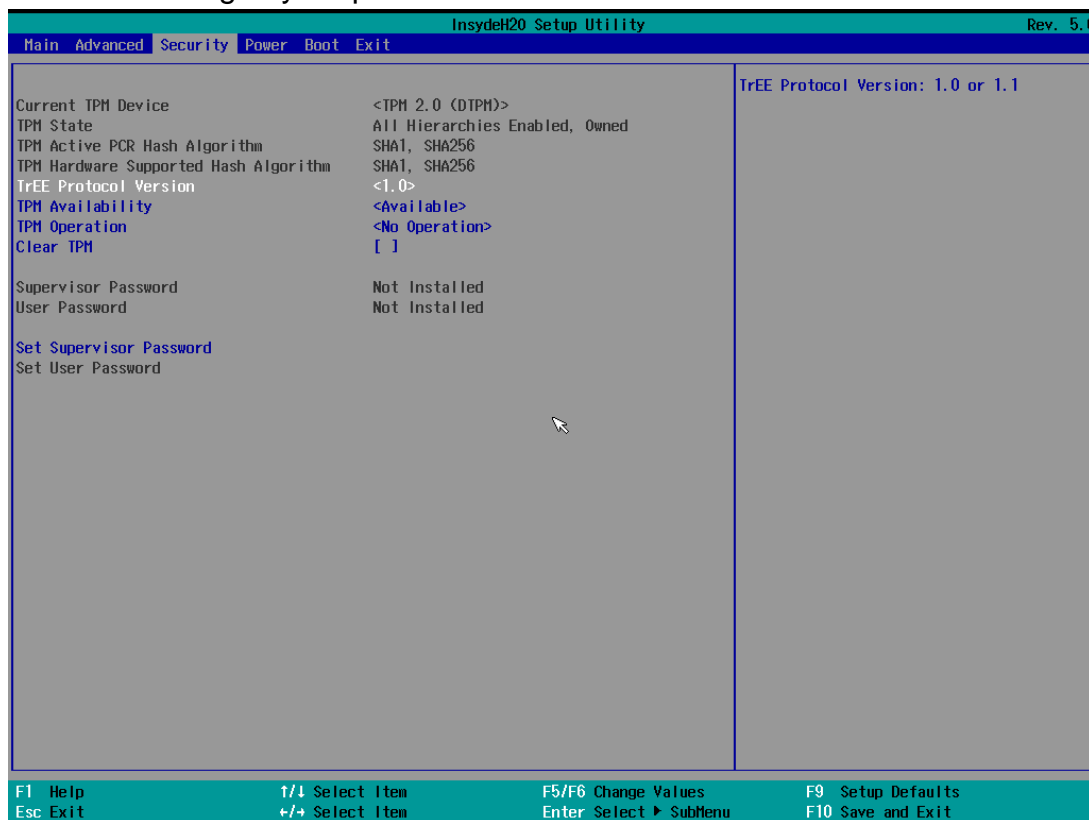

BIOS Setting	Description	Setting Option	Effect
TrEE Protocol Version	Select TrEE Protocol Version: 1.0 or 1.1	1.0/ 1.1	Select TrEE Protocol Version
TPM Availability	Configure TPM Availability settings	Available	Available
		Hidden	When hidden do not expose TPM to 0
TPM Operation	Configure TPM Operation settings	No Operation/ Enabled/ Disabled/ Change EPS	Select one of the supported operation to change TPM2 state

## 4.2.5 Power Menu

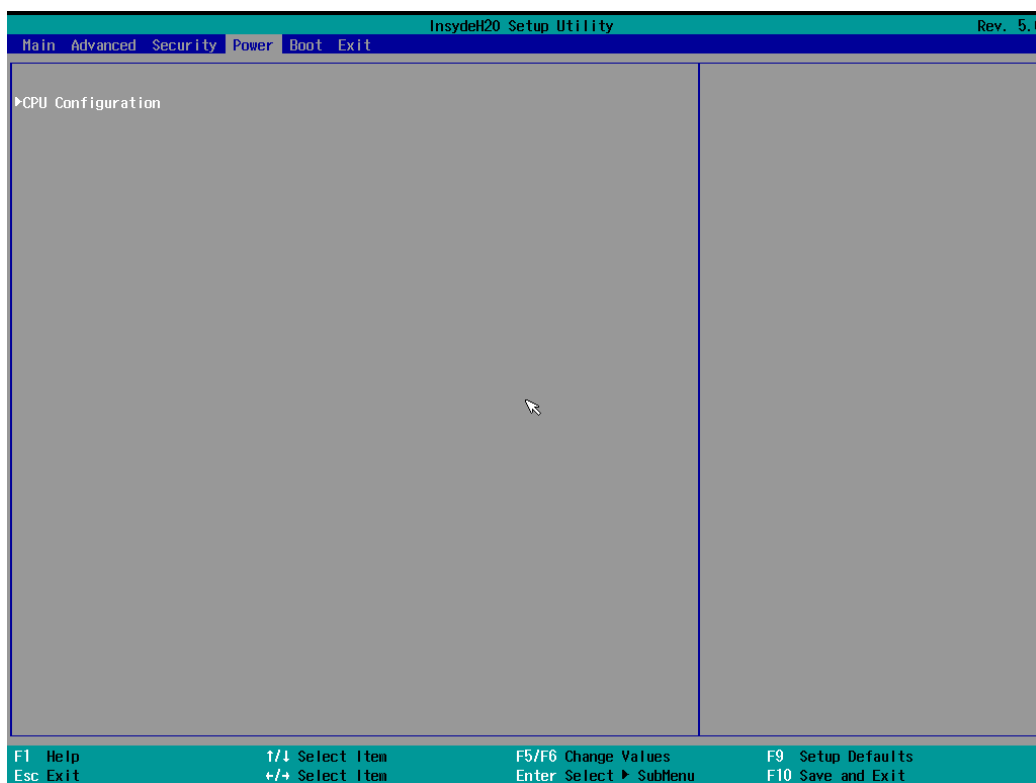

BIOS Setting	Description	Setting Option	Effect
CPU Configuration	Check CPU Configuration	Press Enter	Opens sub-menu

### 4.2.5.1 CPU Configuration

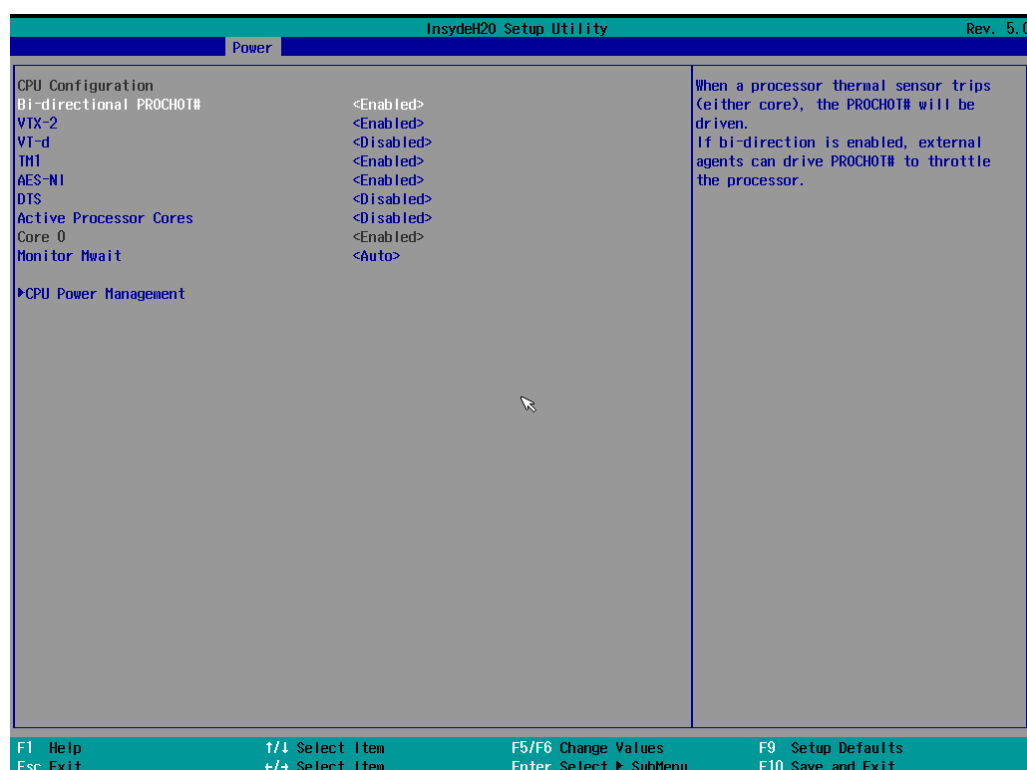

BIOS Setting	Description	Setting Option	Effect
Bi-directional PROCHOT#	When a processor thermal sensor trips (either core) , the PROCHOT# will be driven	Enabled/ Disabled	If bi-direction is enabled, external agents can drive PROCHOT# to throttle the processor
VTX-2	Configure VTX-2 support settings	Enabled/ Disabled	Enable or disable VTX-2 support
VT-d	Configure VT-d support settings	Enabled/ Disabled	Enable or disable VT-d support. <b>*Please disable IPU when you want to enable VT-d feature</b>
TM1	Configure TM1 settings	Enabled/ Disabled	Enable or disable TM1
AES-N1	Configure AES-N1 settings	Enabled/ Disabled	Enable or disable AES-N1
DIS	Configure DIS settings	Enabled/ Disabled	Enable or disable Digital Thermal Sensor
Active Processor Cores	Configure Active Processor Cores settings	Enabled/ Disabled	Enable this to disable core in each processor package
Monitor Mwait	Configure Monitor Mwait settings	Disabled/ Enabled/ Auto	Disable/ Enable Monitor Mwait. If Auto is selected, Monitor Mwait will be disabled for Linux/ Yocto OS with B1 silicon. For the rest Monitor Mwait will be enabled.
CPU Power Management	Check CPU Power Management Configuration	Press Enter	Opens sub-menu

### 4.2.5.2 System Power Options

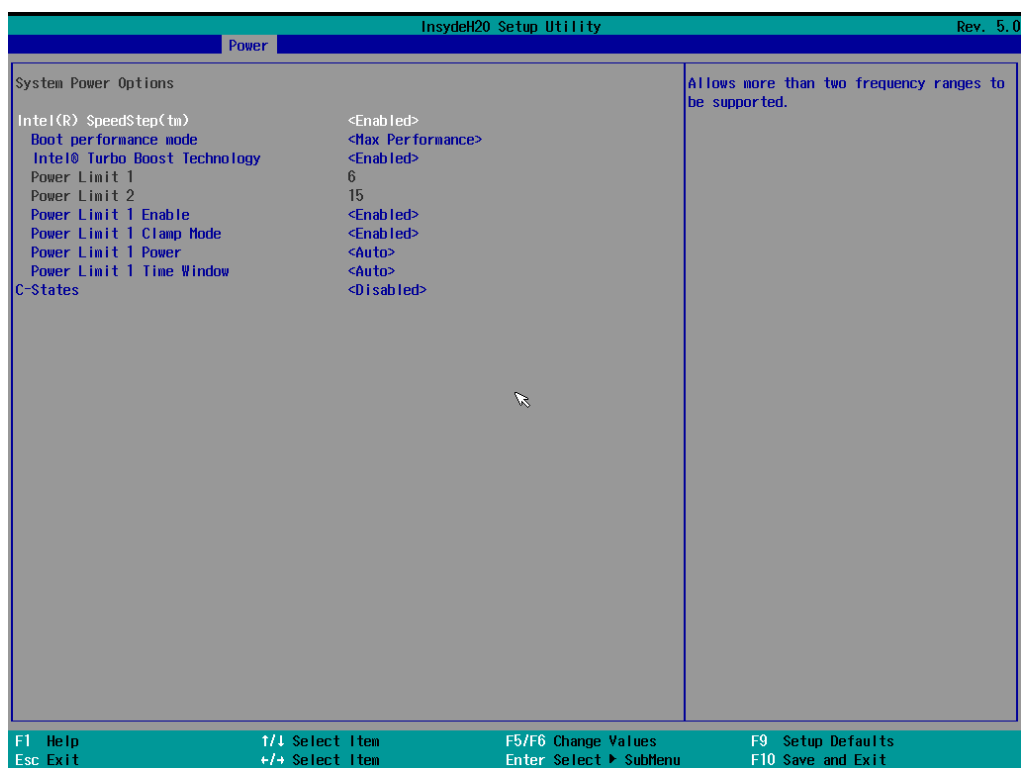

BIOS Setting	Description	Setting Option	Effect
Intel® SpeedStep (tm)	Allows more than two frequency range to be supported	Enabled/ Disabled	Enable/ Disable Intel® SpeedStep (tm)
Boot Performance Mode	Configure Boot Performance Mode settings	Max Performance/ Max Battery	Select the performance state that the BIOS will set before OS handoff
Intel® Turbo Boost Technology	Configure Intel® Turbo Boost Technology settings	Enabled/ Disabled	Enable to automatically allow processor cores to run faster than the base operating frequency if it is operating below power, current, and temperature specification limits.
Power Limit 1 Enable	Configure Power Limit settings	Enabled/ Disabled	Enable/ Disable Power Limit
Power Limit 1 Clamp Mode	Configure Power Limit Clamp Mode settings	Enabled/ Disabled	Enable/ Disable Power Limit Clamp Mode
Power Limit 1 Power	Power Limit 1 in Watts	Auto/ 6~25	Auto will program Power Limit 1 based on silicon default support value
Power Limit 1 Time Window	Power Limit 1 Time Value in Seconds	Auto/ 1 ~128	Auto will program Power Limit 1 Time Window based on silicon default support value
C-States	Configure C-States settings	Enabled/ Disabled	Enable/ Disable C-States



### 4.2.3 Boot Menu

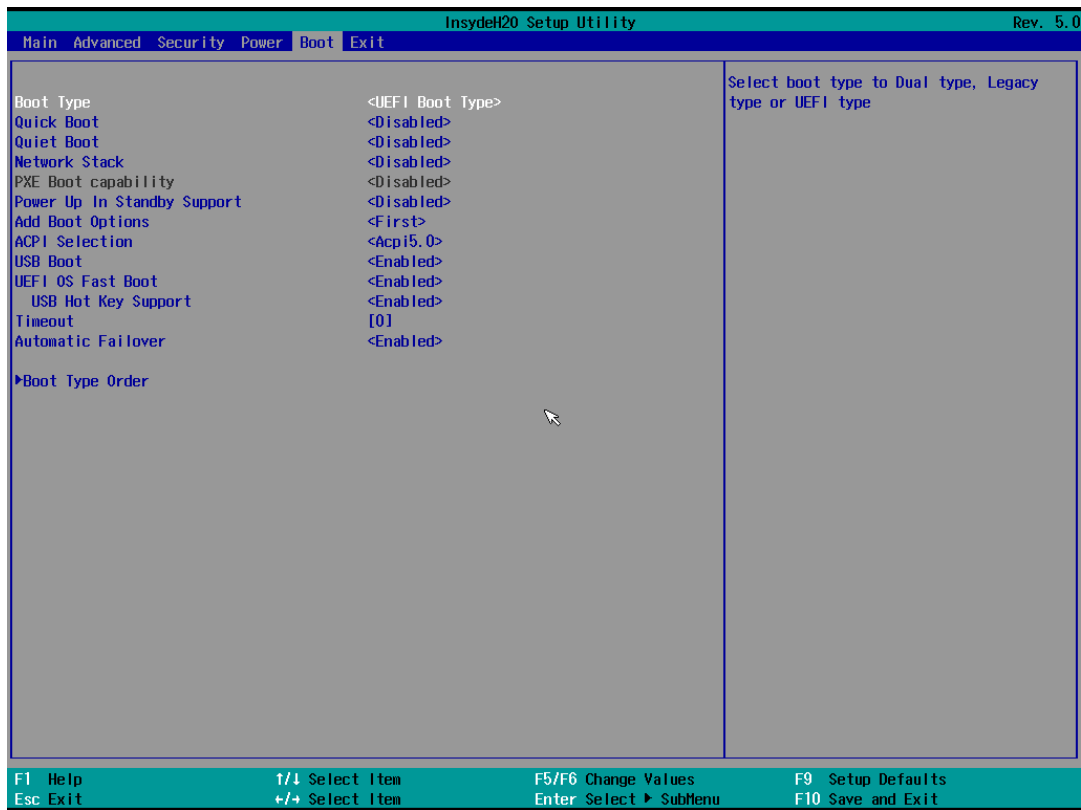

BIOS Setting	Description	Setting Option	Effect
Boot Type	Configure Boot Type settings	Dual / Legacy/ UEFI	Select boot type to Dual, Legacy or UEFI type
Quick Boot	Configure Quick Boot settings	Enabled/ Disabled	Allows InsideH20 to skip certain tests while booting. This will increase the time needed to boot the system
Quiet Boot	Configure Quiet Boot settings	Enabled/ Disabled	Disables or enables booting in Text Mode
Network Stack	Configure Network Stack settings	Enabled/ Disabled	Network Stack support: Windows 8 BitLocker Unlock UEFI IPv4/ IPv6 PXE Legacy PXE OPRM
Power Up Standby Support	Configure Power Up Standby Support settings	Enabled/ Disabled	Disable or enable power in Standby Support. The PUIS feature set allows devices to be powered-up into the Standby power management state to minimize inrush current at power –up and to allow the host to sequence the spin-up of devices
Add Boot Options	Position in Boot order for Shell, Network and Removable	First/ Last	Select Add Boot Options first or last
ACPI Selection	ACPI Selection	Acpi1.0B/ Acpi3.0/ Acpi4.0/ Acpi5.0/ Acpi6.0/ Acpi6.1	Select booting to
USB Boot	Configure USB Boot settings	Enabled/ Disabled	Disable or enable booting to USB boot devices.
UEFI OS Fast Boot	Configure UEFI OS Fast Boot settings	Enabled/ Disabled	If enabled the system firmware does not initialize keyboard and check for firmware menu key
USB Hot Key Support	Configure USB Hot Key Support settings	Enabled/ Disabled	Enable/ Disable to support USB hot key while booting. This will increase the time needed to boot the system
Automatic Failover	Configure Automatic Failover settings	Enabled	If boot to default device fail, it will directly try to boot next device
		Disabled	If boot to default device fail, it will pop up warning message then go into firmware UI
Boot Type Order	Check Boot Type Order Configuration	Press Enter	Opens sub-menu

### 4.2.3.1 Boot Type Order

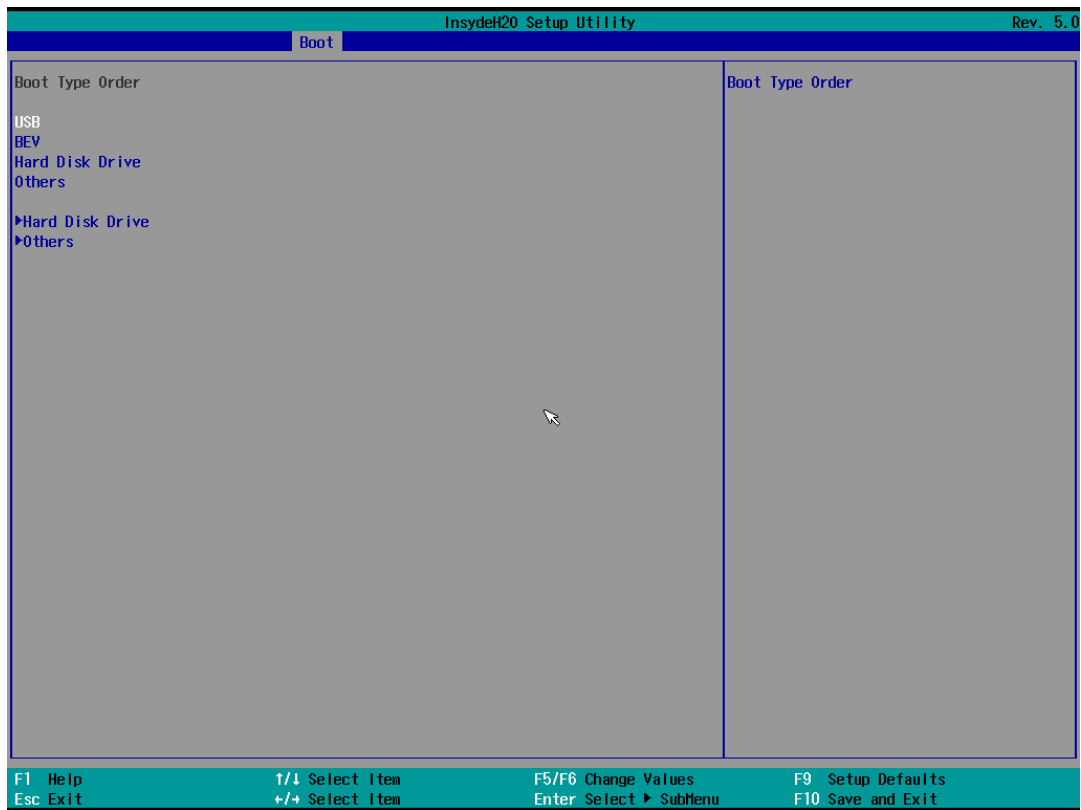

### 4.2.3 Exit Menu

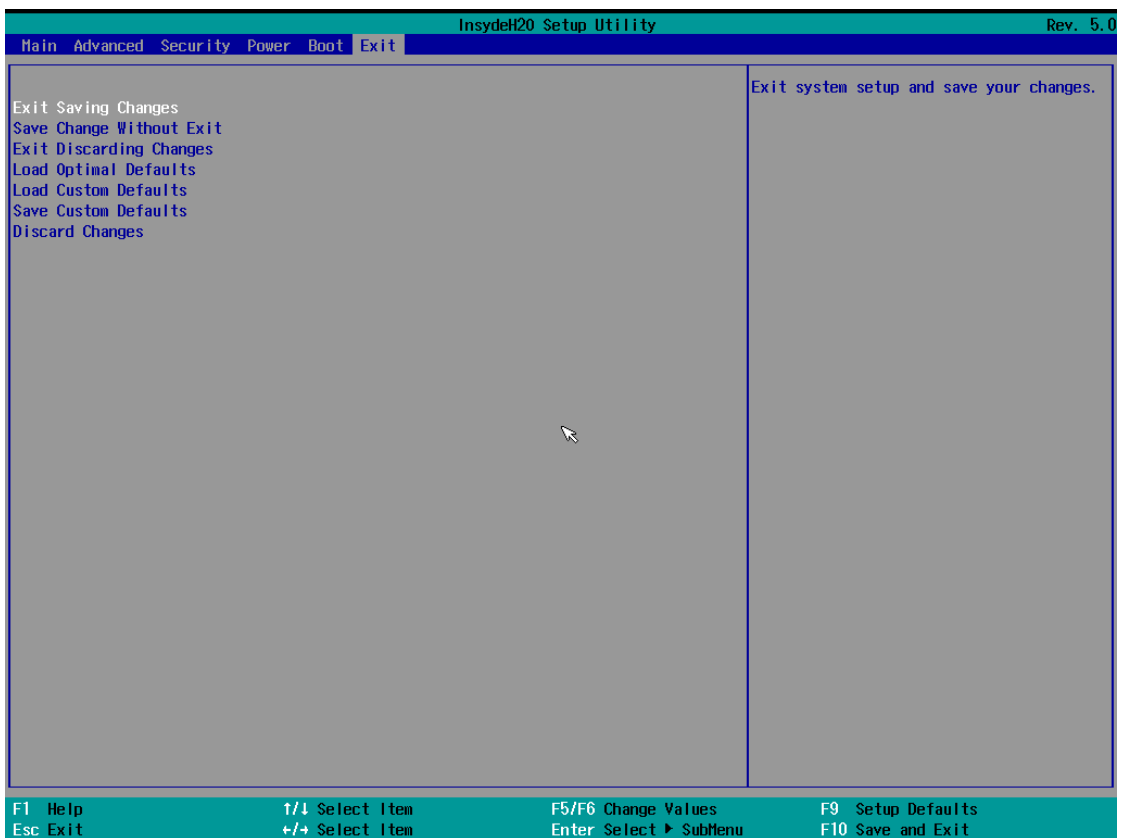

## 4.3 Using Recovery Wizard to Restore Computer

**Note:**

Before starting the recovery process, make sure to backup all user data. The data will be lost after the recovery process.

**Important:**

Before starting the recovery process, remove the PCI/ PCIe card and CFast card.

To enable quick one-key recovery procedure:

1. Connect the computer to the power source. Make sure the computer stays plugged in to power source during the recovery process.
2. Turn on the computer, and when the boot screen shows up, press **Tab+ F6** to initiate the Recovery Wizard.
3. The following screen shows the Recovery Wizard. Click **Recovery** button to continue.



4. A warning message about data loss will show up. Make sure the data is backed up before recovery, and click **Yes** to continue.





5. Wait the recovery process to complete. During the recovery process, a command prompt will show up to indicate the percent of recovery process complete. The system will restart automatically after recovery completed.

## 4.4 How to Enable Watchdog

To enable Watchdog, you need to download Winmate Watchdog utility. Find more information on Watchdog in “Watchdog Guide” that you can download from Winmate Download Center or File Share. Refer to the User Manual for more details.

To enable watchdog in Watchdog AP follow the instructions below:

1. On the right bottom side of the desktop screen, click  **triangle button** to show hidden icons.
2. Click  icon to open Watchdog utility.

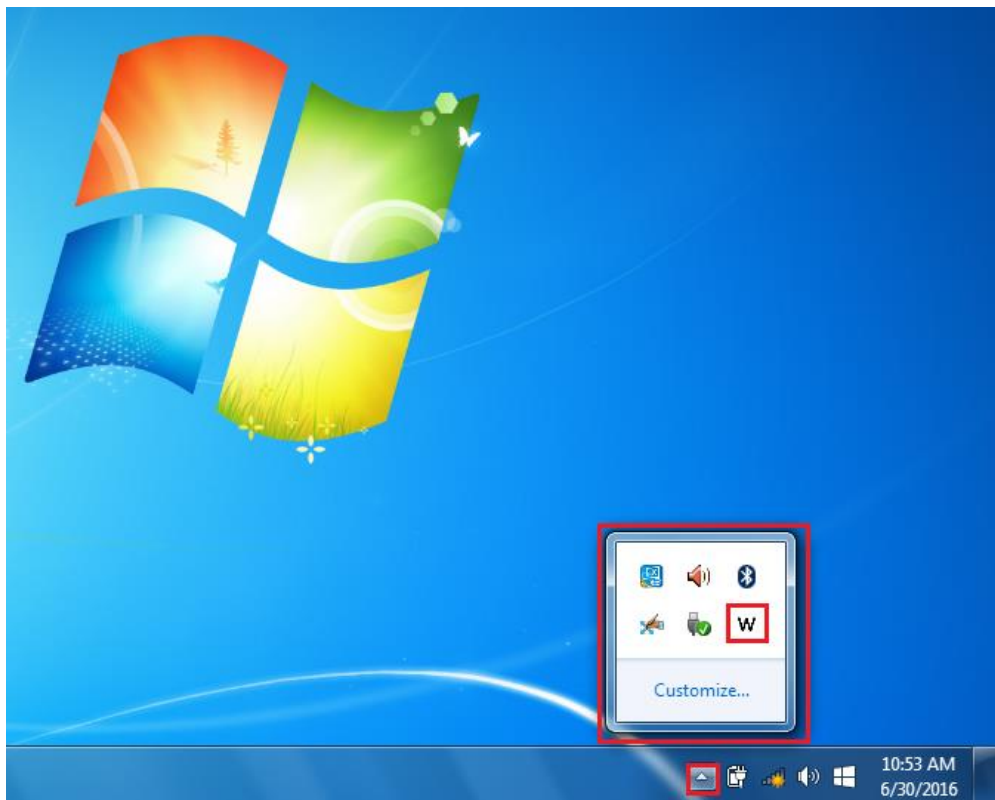

3. In Watchdog utility window set countdown time and periodically feed time, or disable watchdog.

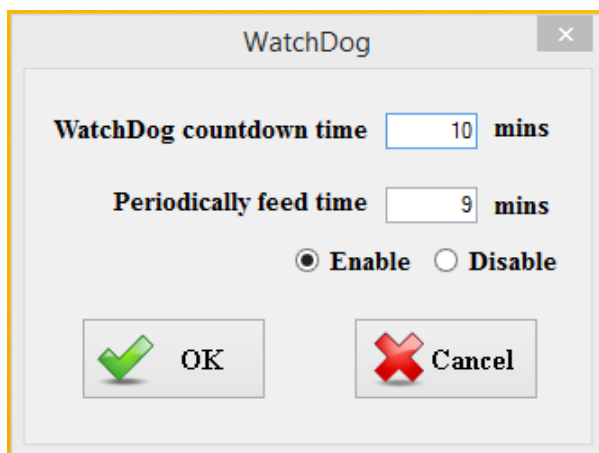

**Example:**

Every 10 min watchdog will monitor the system, in case any error occurs the system will restart automatically when the countdown time reaches 0.

Every 9 min watchdog timer will be reset to 10 min.

Setting	Description
Watchdog Countdown Time	The system automaticity restarts when this countdown time reaches zero. <i>Default: 10 min</i>
Periodically Feed Time	To set a cycle time to automatically reset watchdog timer. <i>Default: 9 min</i>
Enable / Disable	Enable or disable watchdog. <i>Default: Enable</i>

## **DRIVER INSTALLATION**

This chapter provides instructions on how to install drivers on the EAC Mini IoT Gateway.

# 5

## CHAPTER 5: DRIVER INSTALLATION

This chapter provides instructions on how to install drivers on the EAC Mini EACIL20 IoT Gateway.

Notice that pictures in this example are for Windows 10 OS.

### 5.1 Chipset Driver Installation

To install chipset driver:

1. Open the driver CD and double-click on Chipset driver.

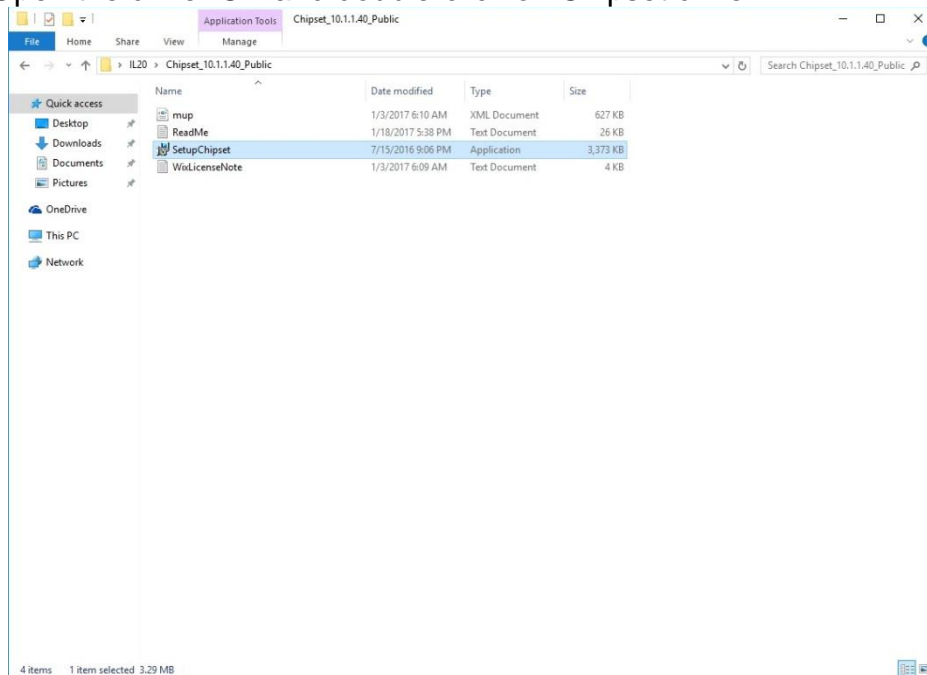

2. The system opens installation window, click **Next** to continue.

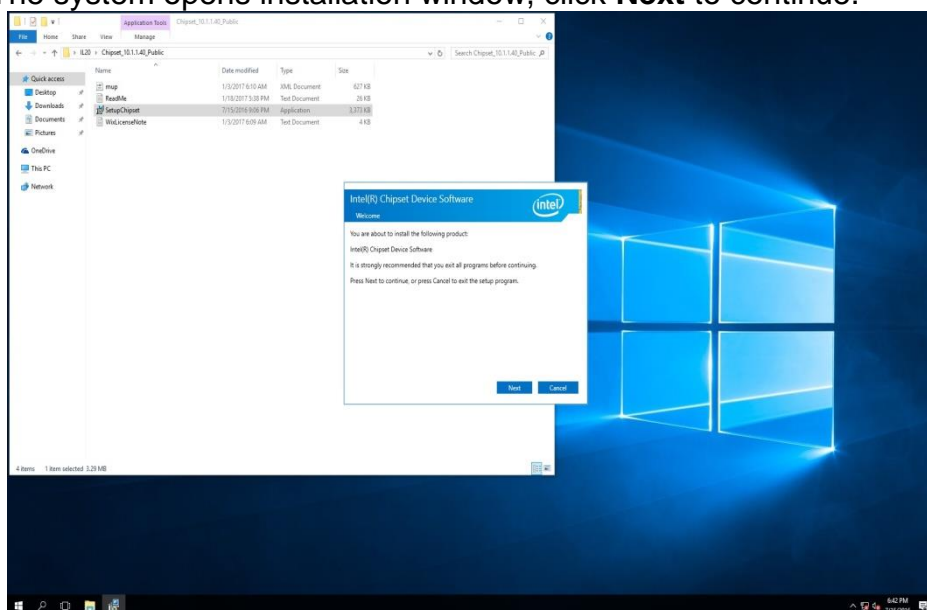



3. Click **Accept** to agree to the license terms.

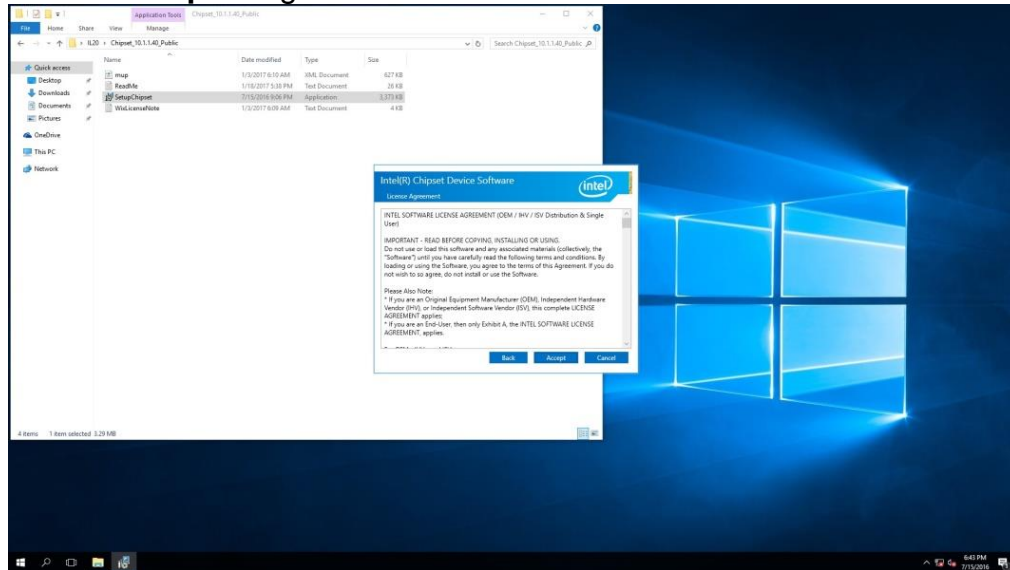

4. Check installation details and click **Install**.

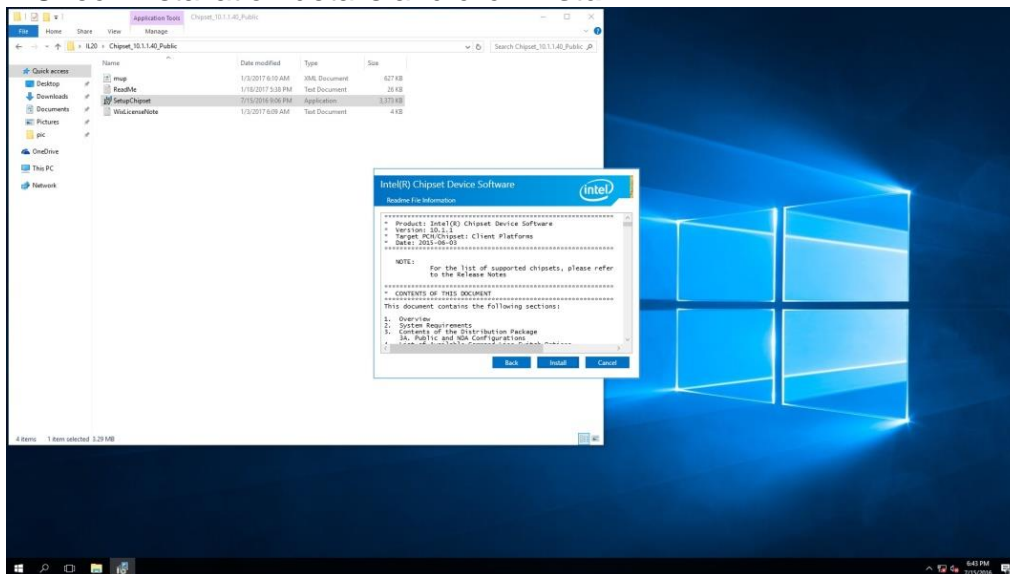

5. The installation is complete, click **Finish** to exit installation window.

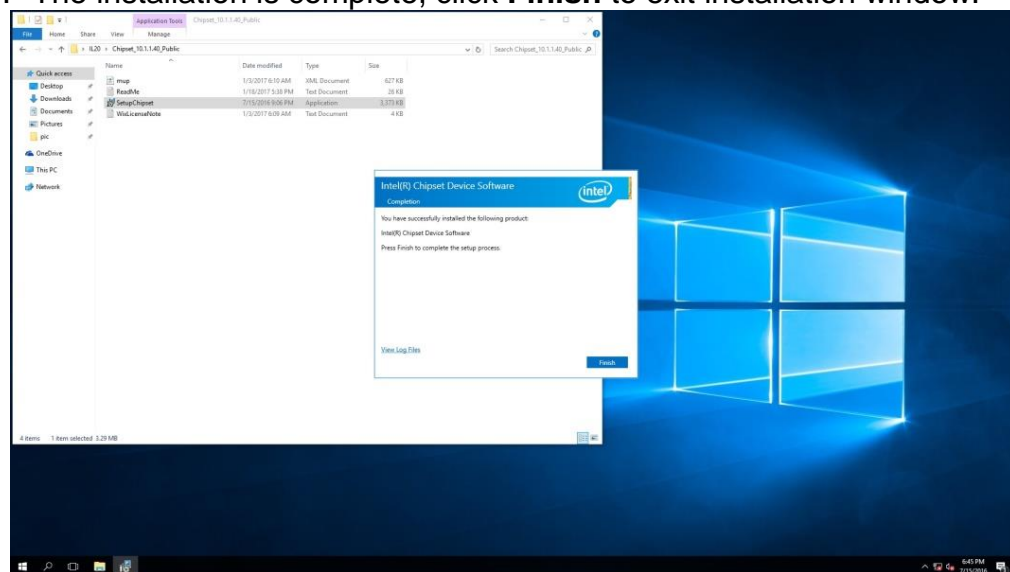

## 5.2 Graphic Driver Installation

To install graphic driver:

1. Open the driver CD and double-click on Graphic driver.

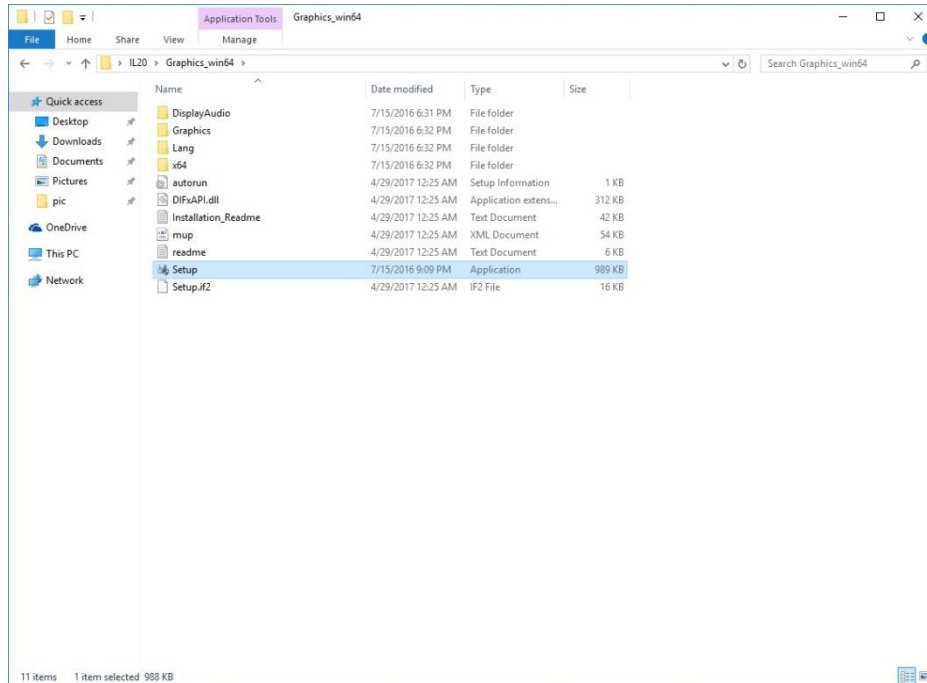

2. The system opens installation window, click **Next** to continue.

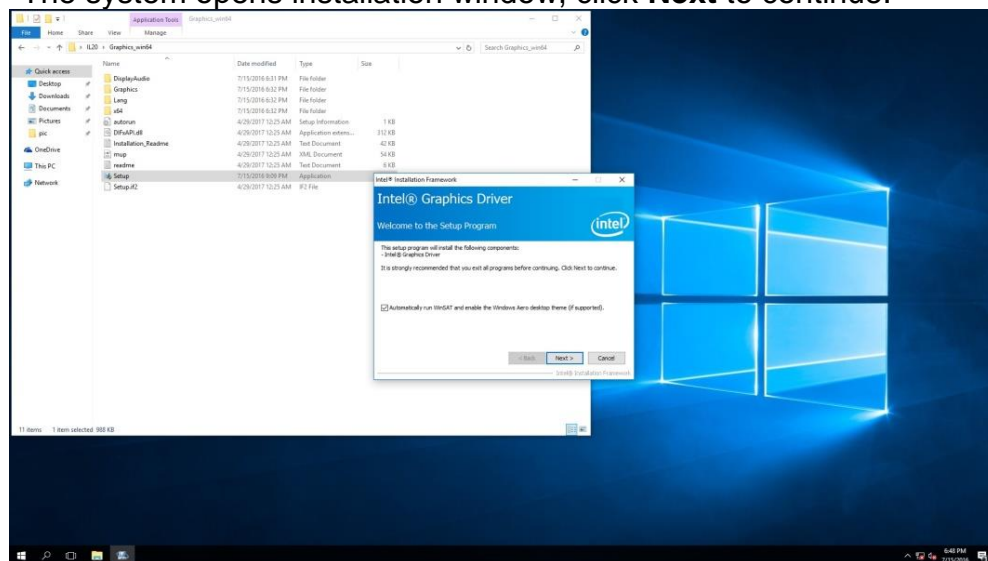

3. Click **Accept** to agree to the license terms.

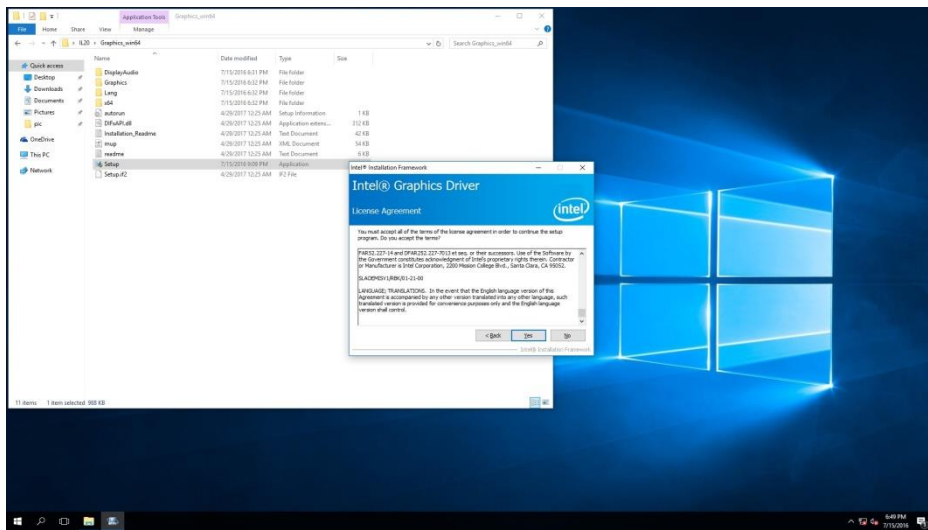

4. Check installation details and click **Install**.

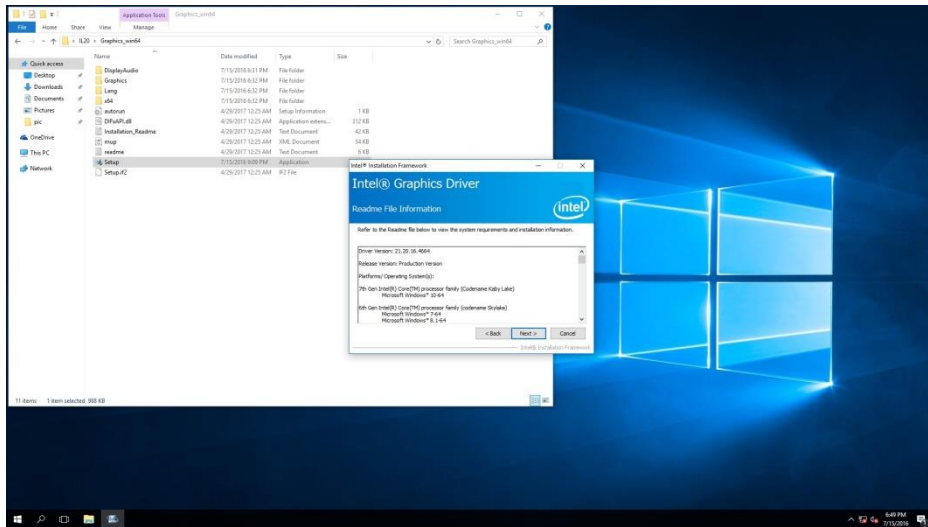

5. Wait for the system to install the driver.

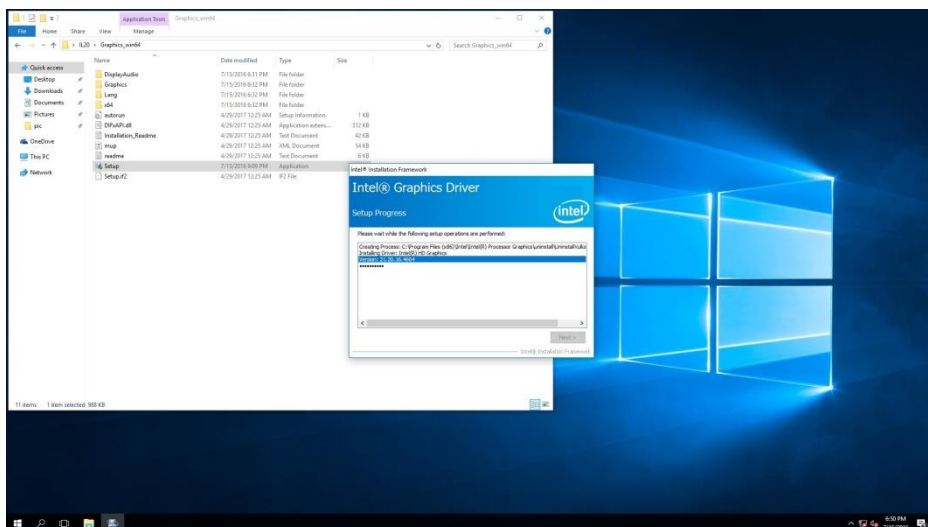



## 5.3 TXE (Trusted Execution Engine) Driver Installation

To install TXE (Trusted Execution Engine) driver:

1. Open the driver CD and double-click on TXE driver.

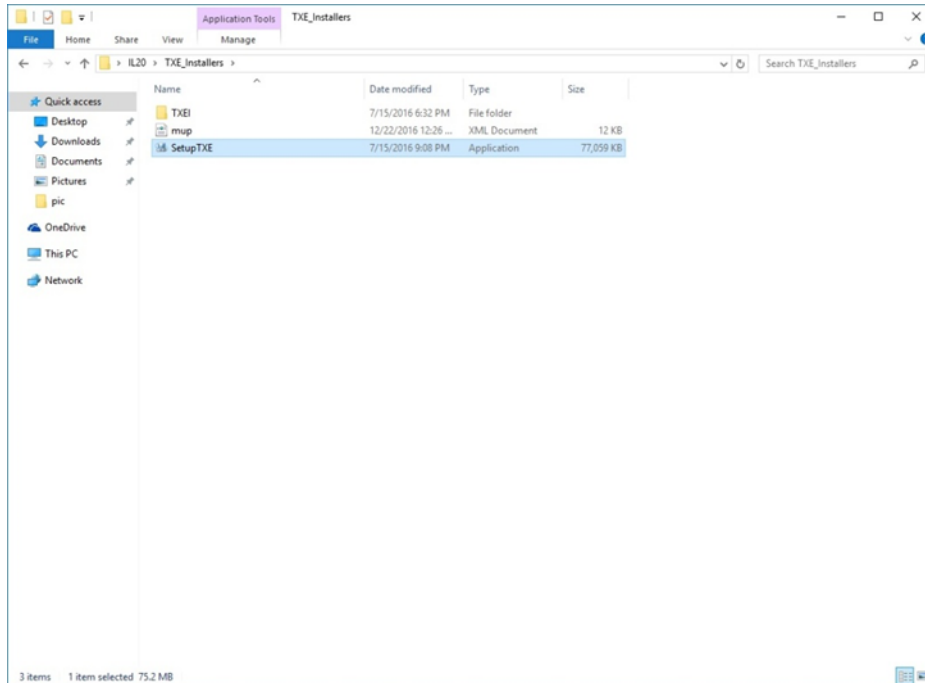

2. The system opens installation window, click **Next** to continue.

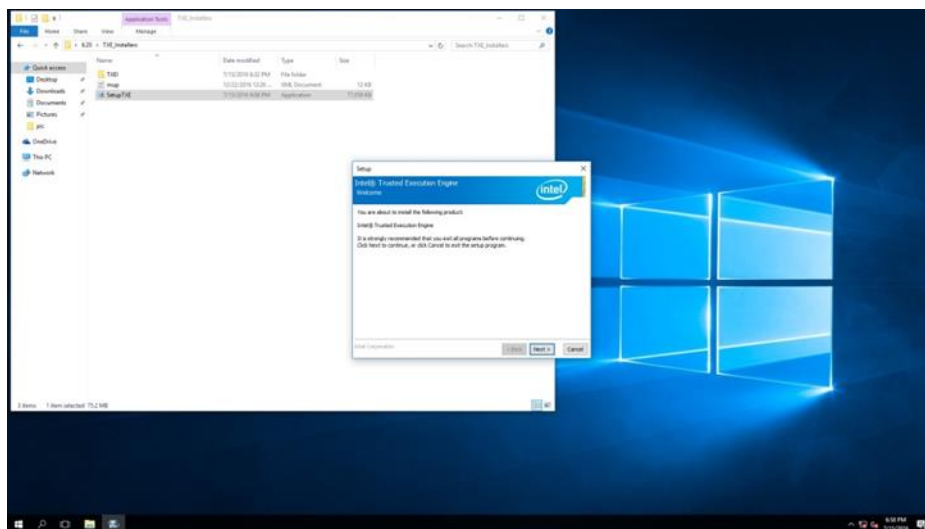

3. Click **Next** to agree to the license terms.

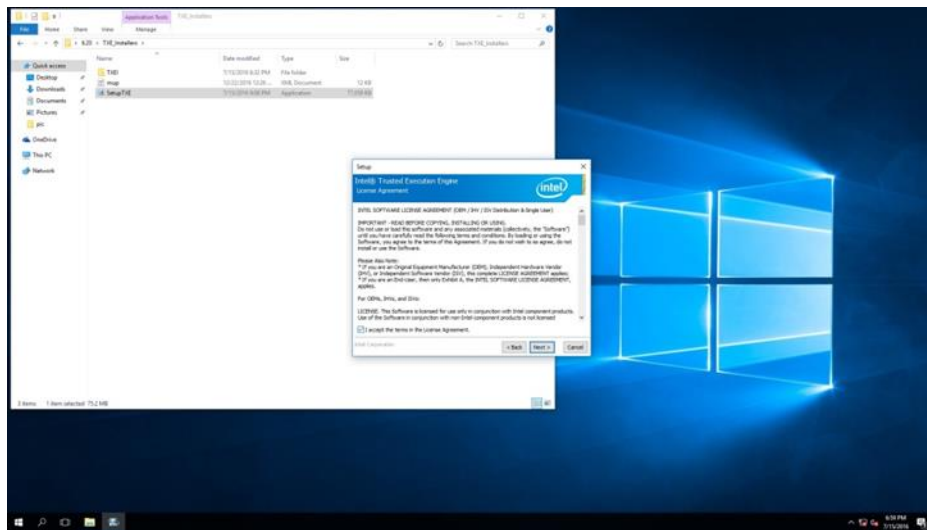

4. Check installation details and click **Next**.

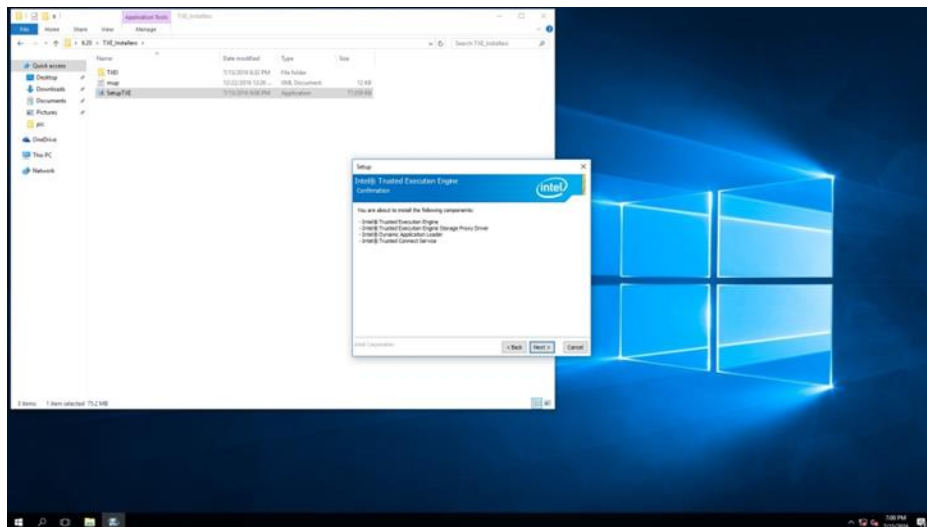

5. Wait for the system to install the driver.

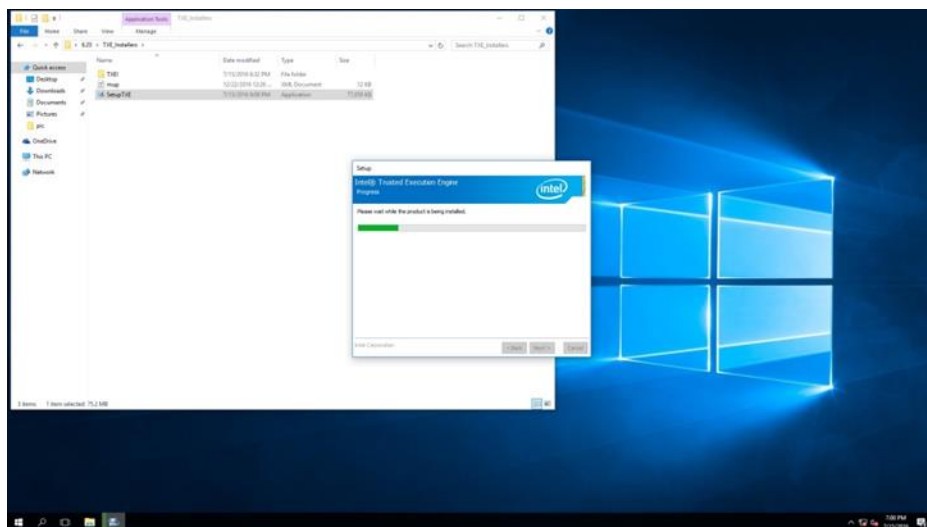

- The installation is complete, click Finish to exit installation window.

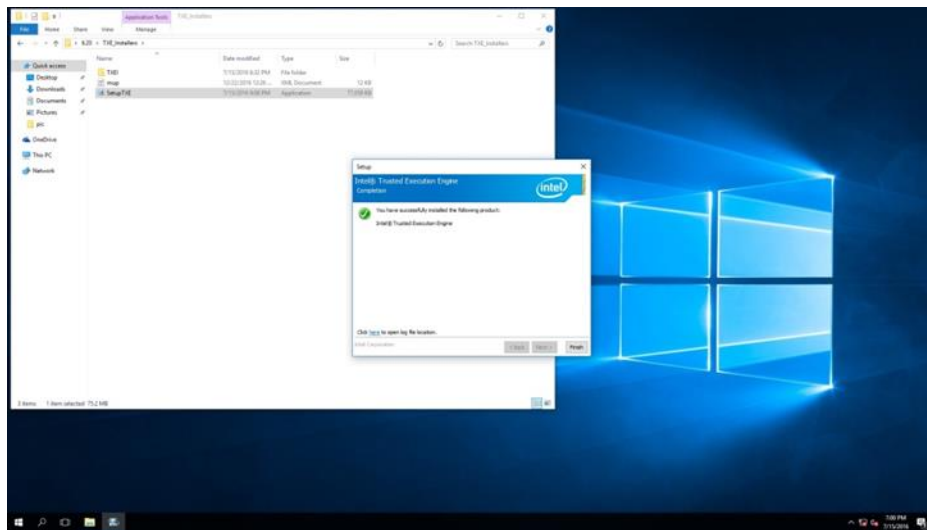

## 5.4 Serial IO Driver Installation

To install Serial IO driver:

1. Open the driver CD and double-click on Serial IO driver.

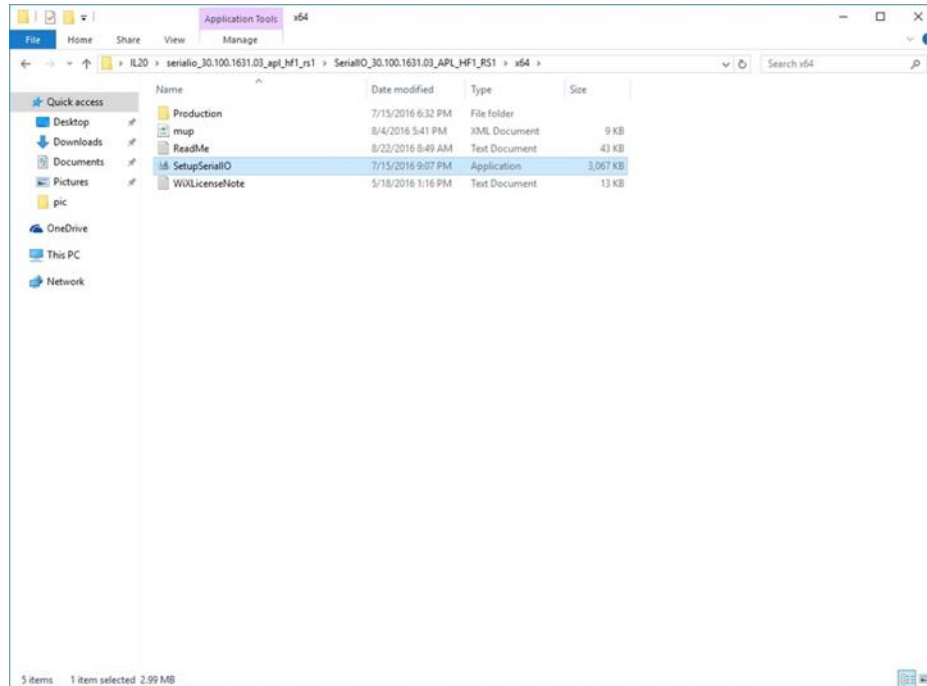

2. The system opens installation window, click **Next** to continue.

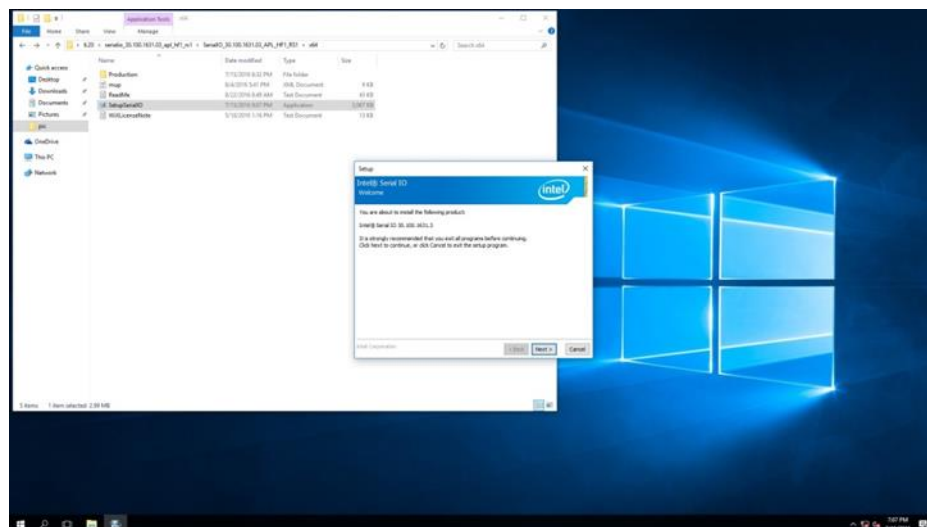





6. Wait for the system to install the driver.

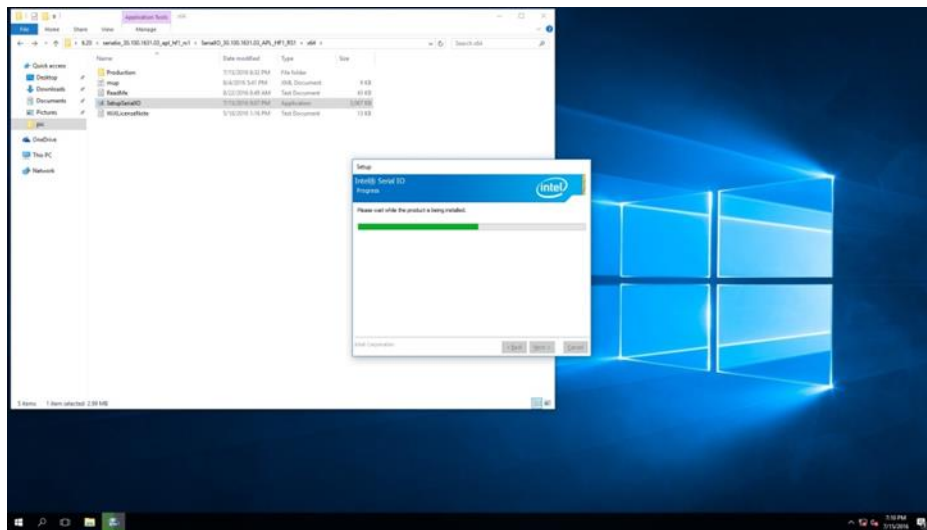

7. The installation is complete, click **Finish** to exit installation window.

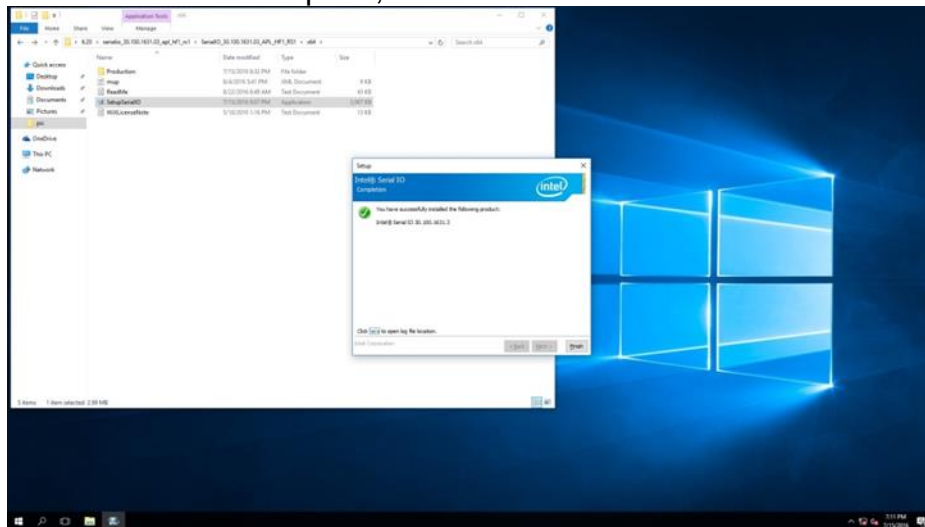

## 5.5 LAN Driver Installation

To install LAN driver:

1. Open the driver CD and double-click on LAN driver.

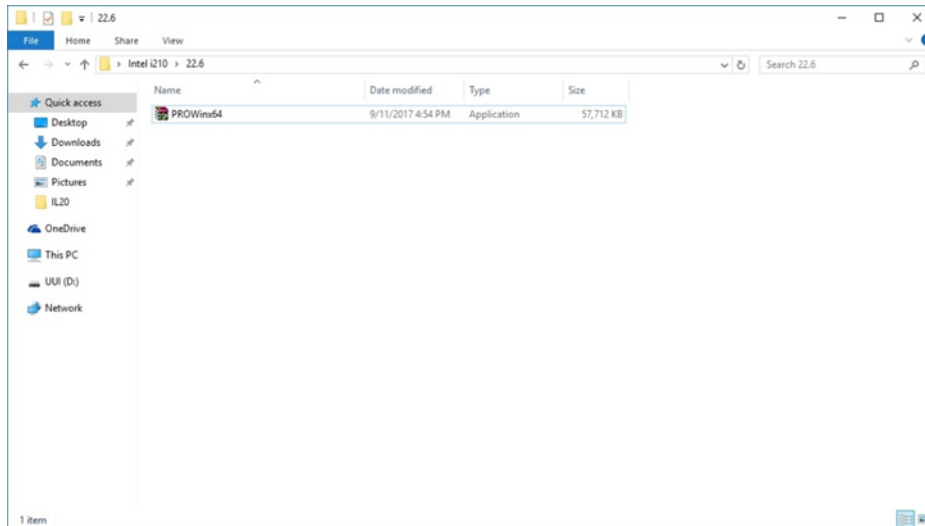

2. The system opens installation window.

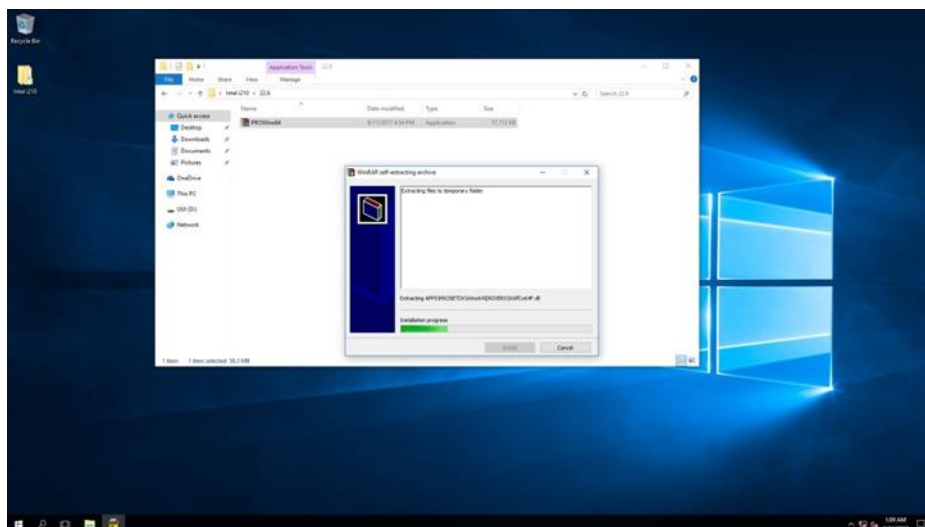

3. Click **Next** to continue.

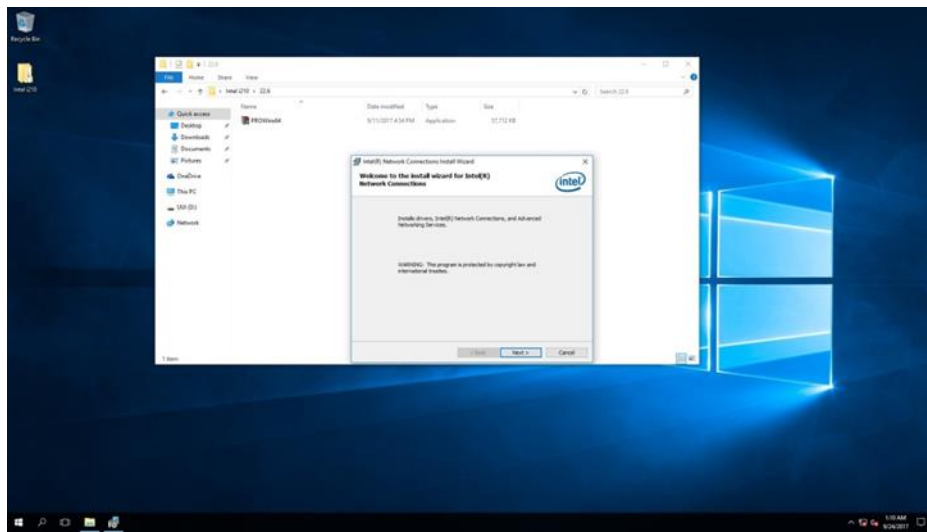

4. Press **Next** to continue.

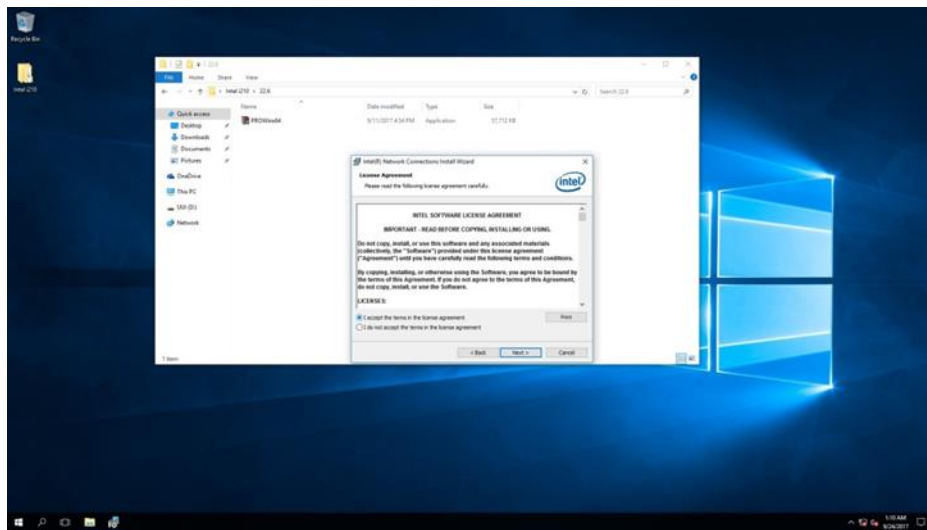

5. Press **Next** to continue.

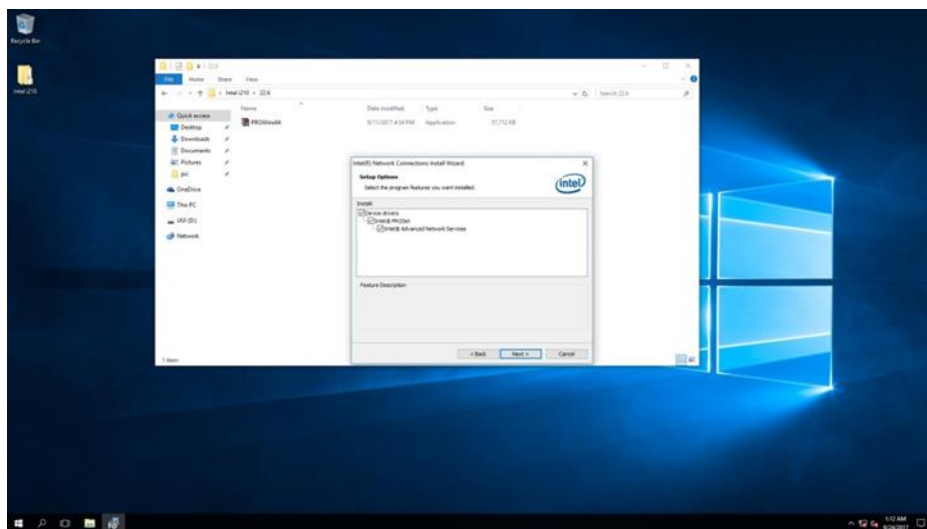

## 6. Press **Install**.

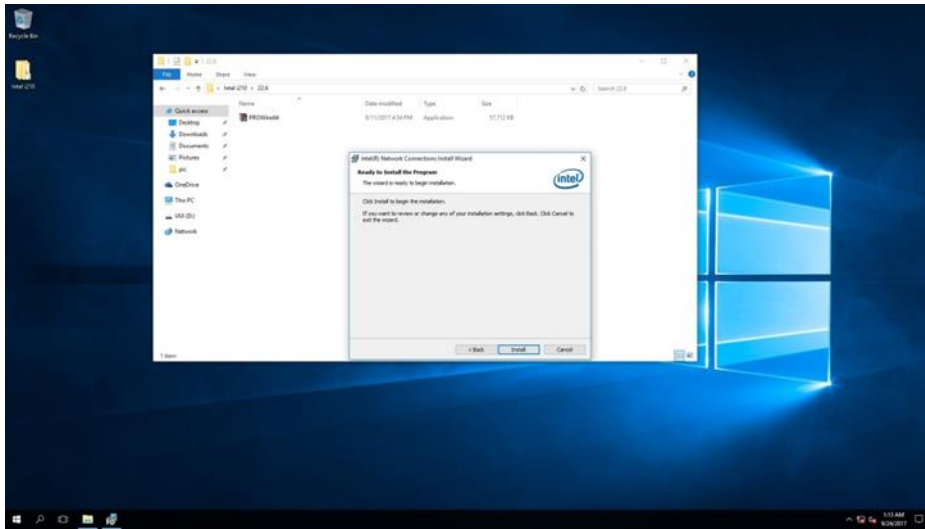

## 7. Wait for the system to install driver.

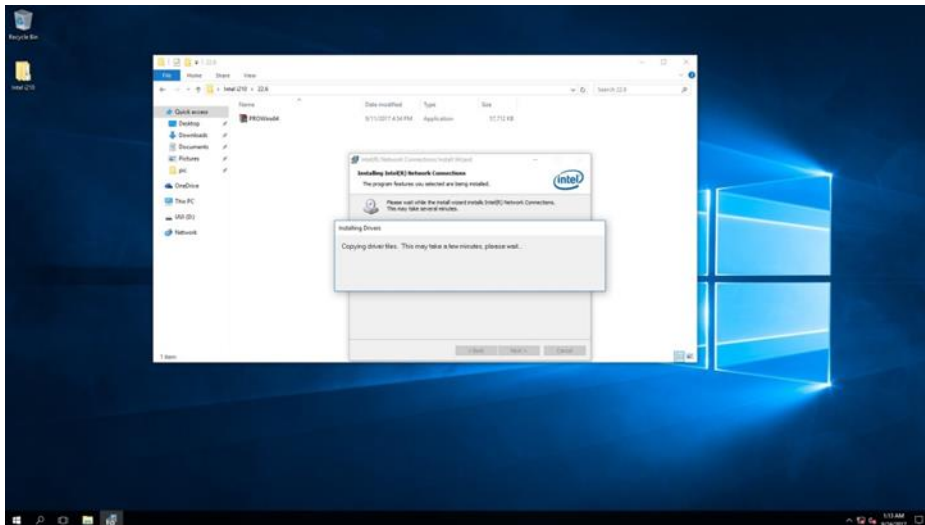

## 8. The installation is complete, click **Finish** to exit installation window.

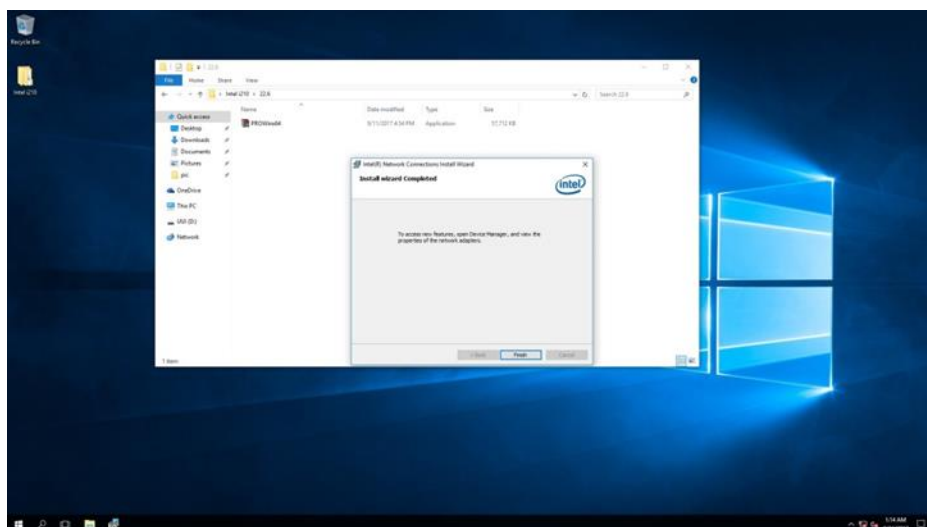

## **TECHNICAL SUPPORT**

This chapter includes pathway for technical support and Software Development Kit (SDK).

# 6

## CHAPTER 6: TECHNICAL SUPPORT

This chapter includes pathway for technical support and Software Development Kit (SDK). Free technical support is available from our engineers every business day. We are always ready to give advice on application requirements or specific information on the installation and operation of any of our products. If any problem occurs fill in [problem report form](#) enclosed and immediately contact us.

### 6.1 Software Developer Support

You can download SDK, drivers and other document from [Winmate Download Center](#) or [Winmate File Share](#).

#### Winmate Download Center

<http://www.winmate.com/> > Support > Download Center > Embedded Computing > EAC Mini EACIL20

### 6.2 Problem Report Form

#### IoT Gateway

Customer name:	
Company:	
Tel.:	Fax:
E-mail:	Date:

Product Serial Number:

---

**Problem Description:** Please describe the problem as clearly as possible. Detailed description of the occurred problem will allow us to find the best solution to solve the problem as soon as possible.

---



---



---



---



---



---



---



---



---



---



---



---



---



---



---



---



---



---



---



---



---



---

## **ORDERING INFORMATION**

This section includes EAC Mini IoT Gateway ordering information.





## APPENDIX A: ORDERING INFORMATION

EAC Mini EACIL20 IoT Gateway available in the following configurations:

Model Name	Configuration
EACIL20-100-A432	Intel N3350, 4G RAM, 32GB eMMC, 2 x USB 3.0, 2 x GbE LAN, 1 x HDMI
EACIL20-100-A432W10	Intel N3350, 4G RAM, 32GB eMMC, 2 x USB 3.0, 2 x GbE LAN, 1 x HDMI, Windows 10
EACIL20-101-A432	Intel N3350, 4G RAM, 32GB eMMC, 2 x USB 3.0, 2 x GbE LAN, 1 x HDMI, Wi-Fi(Client)
EACIL20-102-A432	Intel N3350, 4G RAM, 32GB eMMC, 2 x USB 3.0, 2 x GbE LAN, 1 x HDMI, 4G
EACIL20-103-A432	Intel N3350, 4G RAM, 32GB eMMC, 2 x USB 3.0, 2 x GbE LAN, 1 x HDMI, 3G
EACIL20-104-A432	Intel N3350, 4G RAM, 32GB eMMC, 2 x USB 3.0, 2 x GbE LAN, 1 x HDMI, Access Point
EACIL20-100-A464	Intel N3350, 4G RAM, 64GB eMMC, 2 x USB 3.0, 2 x GbE LAN, 1 x HDMI,
EACIL20-100-A464W10	Intel N3350, 4G RAM, 64GB eMMC, 2 x USB 3.0, 2 x GbE LAN, 1 x HDMI, Windows 10

Additional ordering options:

Item	Specifications
Storage	Option : 32GB mSATA
AC Adapter	AC Adapter 12V/40W (P/N 9220123C6000)
Mounting	VESA Mounting Kit (P/N 821118561001) DIN-Rail Mounting Kit (P/N 821118551400)
External Antenna	WLAN External Antenna (P/N 397SM0000002) WWAN External Antenna (P/N 39700000000H)
Expansion Module	EACWSLT-222 4G EACWSLT-223 3G EACWSLT-231 3-port RS232/422/485 w/ isolation EACWSLT-232 24-Channel Digital I/O w/ isolation EACWSLT-233 2-port CANBUS w/ isolation EACWLST-234 4-port USB 2.0 EACWLST-235 2-port RS232/422/485 w/ isolation







---

**Winmate Inc.**

9F, No.111-6, Shing-De Rd., San-Chung District,  
New Taipei City 24158, Taiwan, R.O.C

Tel: 886-2-8511-0288

Fax: 886-2-8511-0211

Email: [sales@winmate.com.tw](mailto:sales@winmate.com.tw)

Official website: [www.winmate.com](http://www.winmate.com)

---