

M101P

Rugged Windows Tablet

Intel® Apollo Lake Pentium N4200

Windows 10 IoT Enterprise



Quick Start Guide

Advisory Conventions

Four types of advisories are used throughout the user manual to provide helpful information or to alert you to the potential for hardware damage or personal injury.



Note:

A note is used to emphasize helpful information



Important:

An important note indicates information that is important for you to know.



Caution/ Attention

A Caution alert indicates potential damage to hardware and explains how to avoid the potential problem.

[FR] Une alerte d'attention indique un dommage possible à l'équipement et explique comment éviter le problème potentiel.



Warning!/Avertissement!

An Electrical Shock Warning indicates the potential harm from electrical hazards and how to avoid the potential problem.

[FR] Un Avertissement de Choc Électrique indique le potentiel de choc sur des emplacements électriques et comment éviter ces problèmes.

FCC Statement



This device complies with part 15 FCC rules.

Operation is subject to the following two conditions:

- This device may not cause harmful interference.
- This device must accept any interference received including interference that may cause undesired operation

This equipment has been tested and found to comply with the limits for a class "B" digital device, pursuant to part 15 of the FCC rules. These limits are designed to provide reasonable protection against harmful interference when the equipment is operated in a commercial environment. This equipment generates, uses, and can radiate radio frequency energy and, if not installed and used in accordance with the instruction manual, may cause harmful interference to radio communications. Operation of this equipment in a residential area is likely to cause harmful interference in which case the user will be required to correct the interference at his own expense.

CE Notice (European Union)



Electromagnetic Compatibility Directive (2014/30/EU)

- EN55024: 2010/ A1: 2015
 - IEC61000-4-2: 2009
 - IEC61000-4-3: 2006+A1: 2007+A2: 2010
 - IEC61000-4-4: 2012
 - IEC61000-4-5: 2014
 - IEC61000-4-6: 2014
 - IEC61000-4-8: 2010
 - IEC61000-4-11: 2004
- EN55032: 2015/AC:2016
- EN61000-3-2:2014
- EN61000-3-3:2013

Low Voltage Directive (2014/35/EU)

- EN 60950-1:2006/A11:2009/A1:2010/A12:2011/ A2:2013

This equipment is in conformity with the requirement of the following EU legislations and harmonized standards. Product also complies with the Council directions.

Safety Information



Precaution on Battery Pack *Précaution avec le bloc-pile*

Do Not Disassemble, Modify, or Insert Sharp Objects Into the Battery Pack. Electrolyte leakage, generation of heat, ignition or rupture may result.
 [FR] *Ne pas démonter, modifier, ou insérer des objets pointus à l'intérieur du bloc-pile. Une fuite d'électrolyte, la génération de chaleur, l'amorçage ou la rupture peuvent être occasionnés.*

Do Not Short the Positive (+) and Negative (-) Terminals of the Battery. Generation of heat, ignition or rupture may result. When carrying or storing the device, do not place the battery pack together with articles that may contact electricity.
 [FR] *Ne pas court-circuiter les bornes Positive (+) et Négative (-) de la pile, la génération de chaleur, l'amorçage ou la rupture peuvent être occasionnés. Lors du transport et du rangement de l'appareil, ne pas placer le bloc-pile en même temps que des articles pouvant créer un contact électrique.*

Do Not Apply Shocks to the Battery by Dropping It or Applying Strong Pressure to It. Electrolyte leakage, generation of heat, ignition or rupture of battery may occurs.
 [FR] *Ne pas faire subir de choc à la pile en la laissant tomber ou en appliquant une forte pression dessus. Une fuite d'électrolyte, la génération de chaleur, l'amorçage ou la rupture peuvent être occasionnés.*

Do Not Charge the Battery Other Than Methods Those Specified In This Manual. If the battery is not charged using one of the specified methods, electrolyte leakage, generation of heat, ignition or rupture may result.
 [FR] *Ne pas charger la pile par d'autres méthodes que celles spécifiées dans ce manuel. Si la pile n'est pas chargée en utilisant l'une des méthodes spécifiées, une fuite d'électrolyte, la génération de chaleur, l'amorçage ou la rupture peuvent être occasionnés.*

When the Battery Pack Has Deteriorated, Replace It with a New Battery. Continued use of a damaged battery pack may result in heat generation, ignition or battery rupture.
 [FR] *Lorsque la pile est détériorée, la remplacer par une nouvelle pile. L'utilisation continue d'une pile endommagée peut occasionner une génération de chaleur, l'amorçage ou la rupture de la pile.*

Do Not Expose the Battery Pack to Excessive Heat, or Extreme Heat (Near Fire, in Direct Sunlight for example) Generation of heat, ignition or rupture may result

[FR] *Ne pas exposer le bloc-pile à une Chaleur Excessive, ou une Chaleur Extrême (Près d'un feu, sous la lumière du soleil par exemple) Une production de chaleur, l'amorçage ou la rupture peuvent être occasionnés*

Do Not Use the Battery Pack With Any Other Products. The battery pack is rechargeable and is only designed for this specific product. If it is used with a product other than the specified product, electrolyte leakage, generation of heat, ignition or rupture may result.

[FR] *Ne pas utiliser avec un autre produit La batterie est rechargeable et a été conçue pour un produit spécifique. Si elle est utilisée sur un produit différent de celui pour lequel elle a été conçue, des pertes d'électrolytes et une production de chaleur sont possibles, elle risque également de prendre feu ou de casser.*

Do Not Use This Product With Battery Other Than the One Specified.

[FR] *Ne pas utiliser ce produit avec une batterie autre que celle spécifiée*

Discontinue using device immediately if you notice the battery is swelling, or looks puffy or misshapen. Do not attempt to charge or use the device. Do not handle a damaged or leaking battery. Do not let leaking battery fluid come into contact with your eyes, skin or clothing.

[FR] *Si vous remarquez une pile gonflée, élargie ou anormale, cesser l'utilisation de l'appareil immédiatement. N'essayez pas de recharger l'appareil ou de l'utiliser. Ne pas manipuler une pile qui fuit ou qui est endommagée. Ne laissez pas de liquide qui fuit entrer en contact avec vos yeux, votre peau ou vos vêtements.*



General Product Safety
Sécurité générale des produits

- Do not block any ventilation openings. Do not place the product against a wall or in an enclosed space as doing so might impede the flow of cooling air.
- [FR] Ne pas bloquer les ouvertures de ventilation. Ne pas placer le produit contre un mur ou dans un espace clos de façon à entraver la circulation de l'air de refroidissement.*

- Do not place the product near any heat sources such as radiators, warm air intakes, stoves or other heat-generating devices (including amplifiers or other heat producing equipment).
- [FR] Ne pas placer le produit près d'une source de chaleur comme des radiateurs, les arrivées d'air chaud, poêles ou autres produits générant de la chaleur (y compris les amplificateurs ou autre équipement produisant de la chaleur.)*

- Protect the power cord from being crushed or pinched, particularly in the area of the plugs, any receptacles used, and the point of exit from the apparatus. Do not break off the ground pin of the power cord.
- [FR] Empêcher le cordon d'alimentation d'être écrasé ou pincé, en particulier dans les zones de prises, des containers utilisés, et du point de sortie de l'appareil. Ne pas casser la broche de terre du cordon d'alimentation.*

- Do not disregard the safety that a polarized or grounded connection can provide. A polarized connection consists of two plugs, one of which is larger than the other. A grounded connection has two blades and a third one that is grounded. If the main plug provided cannot be inserted into your outlet, consult an electrician to replace your obsolete outlet.
- [FR] Ne pas ignorer la sécurité qu'une prise polarisée ou une prise de terre peut prévoir. Une prise polarisée se compose de deux fiches, dont l'une est plus large que l'autre. Une prise de terre possède deux lames et une troisième qui est la terre. Si la fiche principale fournie ne peut être insérée dans votre prise, consultez un électricien pour remplacer votre prise obsolète.*

Use only accessories specified by the manufacturer.
[FR] Utiliser uniquement les accessoires spécifiés par le fabricant.

This product should not be used near water such as bathtubs, sinks, swimming pools, wet basement, etc.
[FR] Ce produit ne doit pas être utilisé près de l'eau comme les baignoires, les éviers, les piscines, les sous-sols humides, etc.

- Use only with its transport carriage, stand, tripod, console or table specified by the manufacturer or sold with the product. When using a carriage, move the carriage assembly with the product carefully to avoid damage from falling over.
- [FR] Utiliser uniquement avec son chariot de transport, support, trépied, console ou table spécifiés par le fabricant ou vendu avec le produit. Lors de l'utilisation d'un charriot, déplacez l'ensemble charriot avec le produit avec soin pour éviter tout dommage de chute.*

- Unplug this apparatus during lightning storms or when it is not being used for long periods.
- [FR] Débrancher cet appareil durant les orages ou lorsqu'il n'est pas utilisé pendant de longues périodes.*

- Refer all servicing to qualified service personnel. A technical intervention is required when the apparatus has been damaged in any way, for example if the power cord or plug is damaged, liquid has been spilled or objects have fallen inside the unit, if the product has been exposed to rain or moisture, if it does not operate normally or if it has been dropped.
- [FR] Confier toute réparation à du personnel qualifié. Une intervention technique est nécessaire lorsque l'appareil a été endommagé de quelque façon, par exemple si le cordon d'alimentation ou la fiche est endommagé, du liquide a été renversé ou des objets sont tombés à l'intérieur de l'unité, si le produit a été exposé à la pluie ou à l'humidité, s'il ne fonctionne pas normalement ou s'il a été jeté.*



General Guideline
Directive générale

It is recommended to reboot the device when some functions are defect or inactive. If it still can't solve the problems please contact your dealer or agent.

Il est recommandé de redémarrer l'appareil lorsque certaines fonctions sont défectueuses ou inactives. Si le problème persiste, veuillez contacter votre revendeur ou votre agent.

Handling and Maintenance



General Guideline Guide Général

Keep the product at least 13 cm (5 inches) away from electrical appliances that can generate a strong magnetic field such as TV, refrigerator, motor, or a large audio speaker.

[FR] Garder le produit au moins à 13 cm (5 pouces) de distance des appareils électriques qui peuvent générer un fort champ magnétique comme une télévision, un réfrigérateur, un moteur, ou un important haut-parleur.

Do not place heavy objects on top of the tablet computer as this may damage the display.

[FR] Ne pas placer d'objets lourds sur le dessus de l'ordinateur tablette cela peut endommager l'écran.

The screen surface can be easily scratched. Use with care. Do not use paper towels to clean the display but use the included cleaning cloth. Avoid touching it with a pen or pencil.

[FR] La surface de l'écran peut être facilement rayée. Utiliser avec précaution. Ne pas utiliser de serviette en papier pour nettoyer l'écran mais utiliser le chiffon de nettoyage inclus. Éviter de toucher avec un stylo ou un crayon.

To maximize the life of the backlight in the display, allow backlight to automatically turn off as a result of power management. Avoid using a screen saver or other software that prevents the power management from working.

[FR] Pour maximiser la durée de vie du rétroéclairage de l'écran, autoriser le rétroéclairage résultant de la gestion de l'alimentation. Éviter d'utiliser un économiseur d'écran ou un autre logiciel empêchant la gestion de l'alimentation de fonctionner.



Cleaning Guideline Guide de nettoyage

Use a soft cloth moistened with water or a non-alkaline detergent to wipe the exterior of the product.

[FR] Utiliser un chiffon doux humidifié avec de l'eau ou un détergeant non alcalin pour essuyer l'extérieur du produit.

Gently wipe the display with a soft, lint-free cloth. Do not use alcohol or detergent on the product.

[FR] Essuyer délicatement l'écran avec un chiffon doux non pelucheux. Ne pas utiliser d'alcool ou un détergent sur le produit.



Touchscreen Guideline Guide de l'écran tactile

Use your finger or the stylus on the display. Using sharp or metallic object may cause scratches and damage the display, thereby causing errors.

[FR] Utiliser votre doigt ou le stylet sur l'écran. L'utilisation d'un objet pointu ou métallique peut provoquer des rayures.

Use a soft cloth to remove dirt on the display. The touchscreen surface has a special protective coating that prevents dirt from sticking to it. Not using a soft cloth may cause damage to the special protective coating on the touchscreen surface. To clean off hard to remove dirt, blow some steam on the particular area and gently wipe away using a soft cloth.

[FR] Utiliser un chiffon doux pour enlever la poussière sur l'écran. La surface de l'écran tactile a un revêtement protecteur spécial empêchant la saleté de se coller à lui. Ne pas utiliser un chiffon doux peut endommager le revêtement spécial sur la surface de l'écran tactile. Pour nettoyer les saletés plus difficiles à enlever, souffler de la buée sur la zone particulière et essuyer doucement avec un chiffon doux.

Do not use excessive force on the display. Avoid placing objects on top of the display as this may cause the glass to break.

[FR] Ne pas utiliser une force excessive sur l'écran. Éviter de placer des objets au dessus de l'écran cela pourrait provoquer une cassure du verre.

When there is a noticeable discrepancy in the operation of the touchscreen function (your touch does not correlate to the proper location on the screen), recalibrate the touchscreen display.

[FR] Lorsqu'il y a un écart sensible dans le fonctionnement de l'écran tactile (votre contact ne correspond pas à la bonne position sur l'écran), recalibrer l'écran tactile.

Introduction

Congratulations on purchasing Winmate® 10.1-inch Rugged Windows Tablet Computer M101P.

M101P is a rugged tablet PC with robust set of features designed to withstand industrial use while providing high tech solutions that increase productivity, improve safety, and reduce operational costs. The processing power comes from Intel's Apollo Lake processor paired with genuine Intel graphics for high performance. The tablet features a brilliant, in-plane switching with direct optical bonding, projective capacitive touch screen, which is outdoor viewable and offers 1920 x 1200 pixel resolution. Weighing at just 2.7 pounds (approx. 1200 grams) the M101P delivers lightweight mobility in a rugged tablet.

Highlights

- Intel® Apollo Lake Pentium N4200 Processor
- 10.1" 1920 x 1200 IPS LED Panel with direct optical bonding
- Optional 1D/2D Barcode Reader and HF RFID for data collection
- Hot-swappable battery design with optional high capacity battery pack
- IP65 waterproof and dustproof
- Rated for extreme temperature use
- Optional Expansion port for USB / RS232 connection

Unpacking

Check and identify the supplied accessories:

- **Tablet Computer**



- **Standard Battery**
Part No. 98K000A0003T



- **Power Adapter**
Part No. 922D065W19V1



- **Power Cord and Plugs**
Part No. 922D065W19V1



- **Capacitive Stylus**
Part No. 9B0000000415

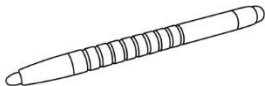

- **Quick Start Guide & Driver CD**



Your package may include other optional accessories based on your order:

- | | | |
|---|--|--|
| <ul style="list-style-type: none"> • Desk Dock
Part No. 98DT00A0000E | <ul style="list-style-type: none"> • Vehicle Charger
Part No. 9226065W19V0 | <ul style="list-style-type: none"> • Carry Bag
Part No. 9B000000003J |
| <ul style="list-style-type: none"> • Vehicle Dock (w/o VGA out)
Part No. 98K000A0003L | <ul style="list-style-type: none"> • High Capacity Battery
Part No. 98K000A0003S | <ul style="list-style-type: none"> • Micro HDMI Cable
Part No. 9491191190K1 |
| <ul style="list-style-type: none"> • Vehicle Cradle
Part No. 98DT00A0000C | <ul style="list-style-type: none"> • Hand Strap
Part No. 98K000A0003J | <ul style="list-style-type: none"> • USB-C to Ethernet Adapter
Part No. 9AN00000000I |
| <ul style="list-style-type: none"> • Battery Charger
Part No. 98KT00A0000F | <ul style="list-style-type: none"> • UHF RFID Reader
Part No. 98K000A0004J | <ul style="list-style-type: none"> • USB-C to RS232 Adapter
Part No. 9AN00000000L |
| <ul style="list-style-type: none"> • Smart Card Reader
Part No. 98K000A0003U | <ul style="list-style-type: none"> • VESA Mount Kit
Part No. 98KT00A0001H | <ul style="list-style-type: none"> • USB-C to USB-A Hub
Part No. 9AN00000000J |
| | <ul style="list-style-type: none"> • Shoulder Strap
Part No. 98K000A0003Q | |

Description of Parts

Dimensions: 271.85 x 198.25 x 19.5 mm

Front:

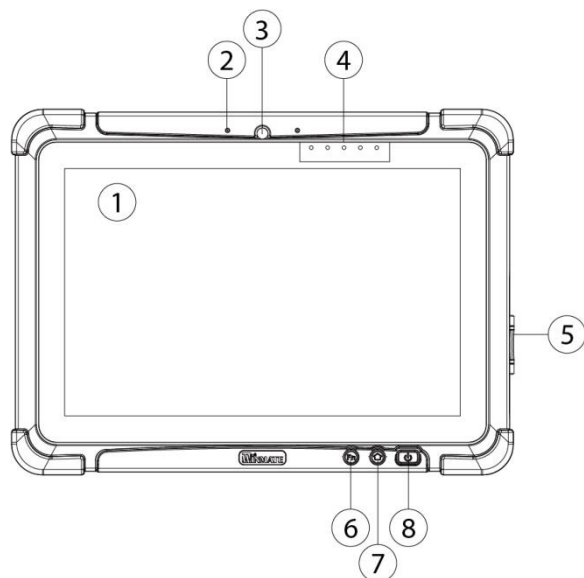

Left:



Right:

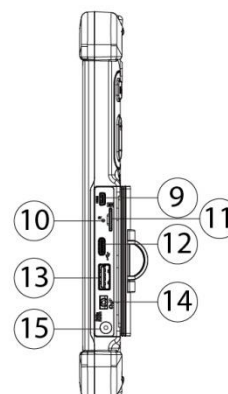

No	Item	Description
1	10.1" Touch Screen	Display and act as one of the inputs for the Tablet Computer
2	Digital Mic with noise cancellation	Use during video recordings and communications.
3	Front Camera	2 Megapixel Webcam
4	Light Sensor and LED Indicators	Show the current status of the Tablet Computer. RF communications, storage, battery status, power status.
5	I/O Cover	Protect I/O ports
6	Fn1 Button	Programmable function key configured by Hottab Utility
7	Menu Button	Hottab Quick Access
8	Power Button	Power on/off tablet

Front LED Indicator Details:

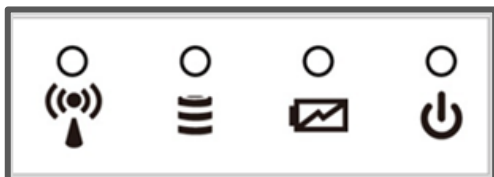

No	Item	Description
9	Micro HDMI	HDMI output to external display
10	Clear CMOS	Hardware reset button.
11	MicroSD Card Reader	Memory card reader port for MicroSD Card
12	USB 3.0 Type C	High speed USB port connects to USB devices, such as USB flash drive, mouse, keyboard, printer, etc. Note: The USB Type-C connector follows USB 3.0 standard, which does not support Alternate Mode (ALT) or USB Power Delivery (USB-PD).
13	USB 3.0 Type A	USB 3.0 port connects to USB devices, such as USB flash drive, mouse, keyboard, printer, etc.
14	Mic In/Line Out	Headset or headphone can be connected (Mic is only supported with 3.5mm 4-pin headset)
15	Power Jack	DC power input jack.

Rear:

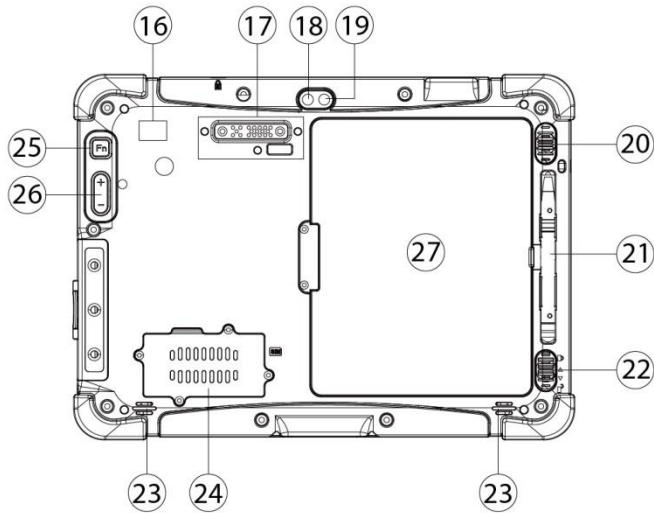

Top:

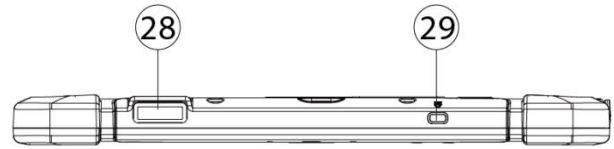



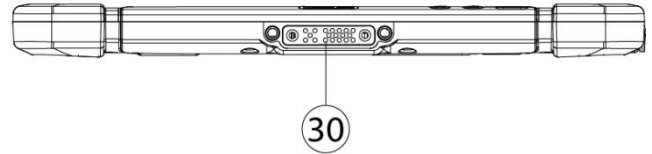

Bottom:



No	Item	Description
16	Optional RFID Reader	RFID Reader for reading RFID tags.
17	Optional Extension Port	Provides connectivity to custom modules for special applications (USB2.0 x 1, RS232 x 1).
18	Camera Flash	LED camera flash to provide flash lighting when use with camera.
19	Rear Camera	8MP Autofocus Camera. Captures photos and videos.
20	Battery Release Slider	Spring-loaded slider that latches the battery in.
21	Touch Pen Slot	Pen holder slot to store touch pen
22	Battery Lock Latch	Latch to lock the battery in place once battery is inserted. Not spring-loaded.
23	Speakers	Emit sounds.
24	3G / LTE Module / SIM card slot	Service window to insert Micro SIM card. Also provide access to 3G / LTE Module.
25	Fn2 Button	Programmable function key configured by Hottab.
26	Brightness or Volume Buttons	Brightness/ Volume Control. (+) Up, (-) Down.
27	Battery	7.4V, typ. 5140 mAh Li-Polymer Battery (2S1P) 7.4V, typ. 10280 mAh Li-Polymer Battery (2S2P, optional)

No	Item	Description
28	Optional Barcode Scanner	Barcode Scanner for reading of 1D/2D barcode.
29	Kensington Lock Port	Provide lock access for Kensington Lock.
30	Docking Connector	Port to docking solutions such as vehicle docking to provide power and external antenna

Indicators

Icon	Indicator	Description
	Power Indicator	Blue – Tablet is ON No light – Tablet is OFF
	Battery Status	Orange –AC adapter is plugged in and charging Blinking Green –AC adapter is plugged in and battery is full charged Solid Red - Low battery (<10%) Blinking Red – Battery is being hot swapped. No light – Battery is in use and more than 10%
	Disk Activity Indicator	Blinking Green - Disk Activity No light - Disk Idling
	RF Communication	Green - One of Wi-Fi/BT/WWAN/GPS is ON No light - Wi-Fi/BT/WWAN/GPS are all OFF

Hotkey for Specific Functions

Physical buttons in addition to its dedicated functions can also be used to emulate commonly used keyboard key strokes. Under different scenario, a single physical button or a combination of physical buttons provide different keyboard key strokes, which are specified below:

In POST (before Windows boots up):

Buttons	Keystroke
Fn1	F6 to enter Recovery Menu
Fn2	F7 to enter BIOS setup screen
Up (+)	Up
Down (-)	Down
Menu + Fn1	Enter
Menu + Up (+)	Right
Menu + Down (-)	Left

In Windows:

Buttons	Keystroke
Menu	Hottab Quick Access
Fn1	Default: Web Browser
Fn2	Default: Camera
Up (+)	Brightness or Volume up.
Down (-)	Brightness or Volume down.
Power	Power ON/ OFF
Up (+) + Down (-)	Ctrl + Alt + Del

Getting Started

To get started:

1. Install SIM card.
2. Install storage card.
3. Install the battery.
4. Charge your tablet.
5. Start the tablet.

Installing SIM Card (For 3G/ LTE Equipped Devices)

The Tablet Computer supports 3G/LTE data connection and fits a Micro-SIM card.

To install the SIM card:

Tools Needed:

Service Windows

Screw: M2x5, 4 pc
Screwdriver: Philips Type , Size #0 , for
M2 screws, torque: 2.0 ± 0.5 kgf.cm

3G/ LTE Module

Screw: M2x3.5, 1 pc
Screwdriver: Philips Type , Size #0 , for
M2 screws, torque: 2.0 ± 0.5 kgf.cm

- ❶ Remove four screws and remove the service window.

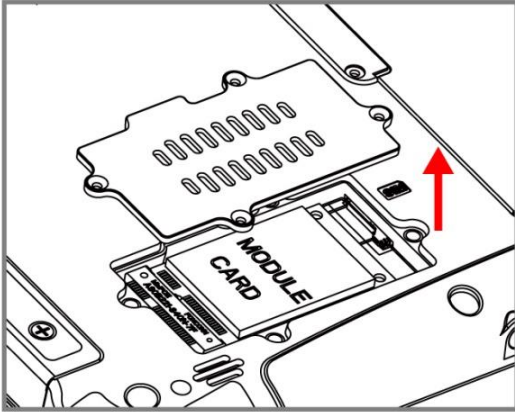

- ❷ Remove the one screw that secures the 3G/ LTE module. Carefully lift the module up. **Do not to damage the connected cables!**

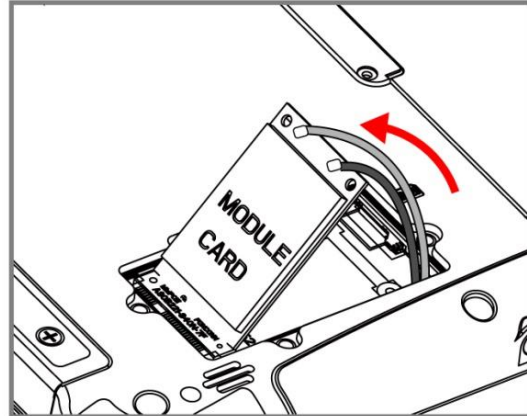

- ❸ Carefully flip and move the 3G/ LTE module and to the right. **Do not disconnect cables!**

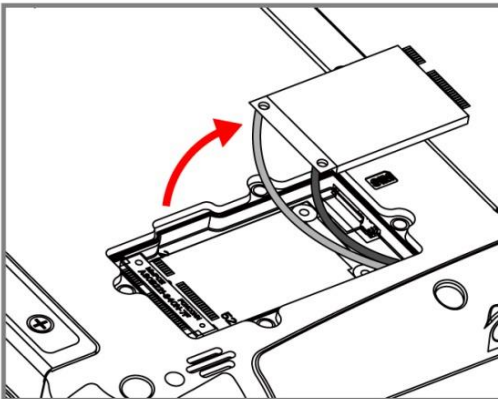

- ❹ Insert SIM-Card all the way in. **Chip/ contact facing down.**

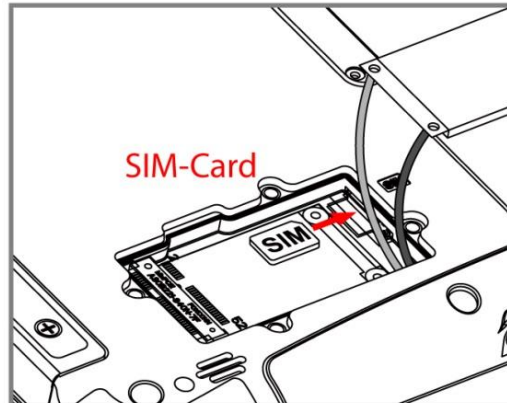

- ❺ Use your hand to carefully pull the cable outside the module card. Re-insert the 3G/LTE module and fasten one screw. Accurately route the cables. **Do not bend cables! Do not pinch/ squeeze the cable!**

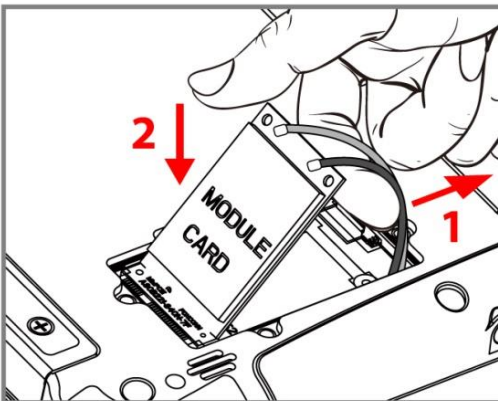

- ❻ Re-insert the service window and fasten with the four screws.

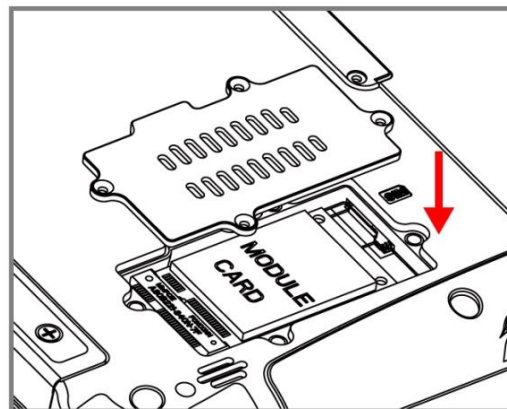

Caution



When re-inserting 3G/LTE module, please pay attention to cable routing. Make sure the cable module does not get squeezed.

Installing a Micro SD Card

Your tablet supports additional storage with an optional microSDXC card slot.

To install Micro SD Card:

1. Open I/O protective cover by pulling out the latch.
2. Insert microSD card into slot with contacts facing down.
3. Press the card in to ensure that it is seated properly.
4. Close I/O protective cover.

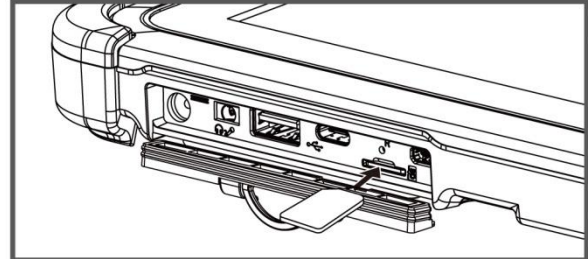
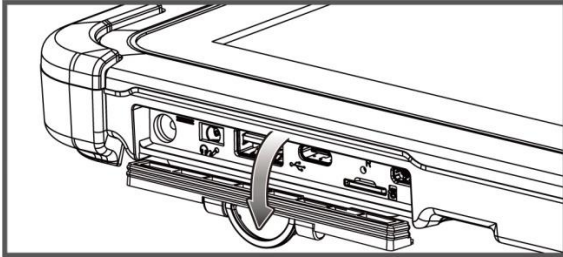

To remove Micro SD Card:

1. Open I/O protective cover by pulling out the latch.
2. Push and release the micro SD card to unlock it.
3. Pull out the micro SD card.

Installing Battery

To install the standard battery pack:

1. Disconnect any cords connected to the tablet computer.
2. Turn the tablet over, back facing up.
3. Locate the Battery Lock Latch and push it to the “Unlocked” position.
4. Locate the Battery Release Slider that is spring-loaded. Pull back and hold.
5. Insert the battery with the connector-pins side first, and then lower the battery into the battery compartment. Continue to hold the Battery Release Slider until the battery is fully inserted.
6. Make sure the battery is completely lowered into the compartment before letting go of the Battery Release Slider. Battery will be flat against the housing once fully inserted.

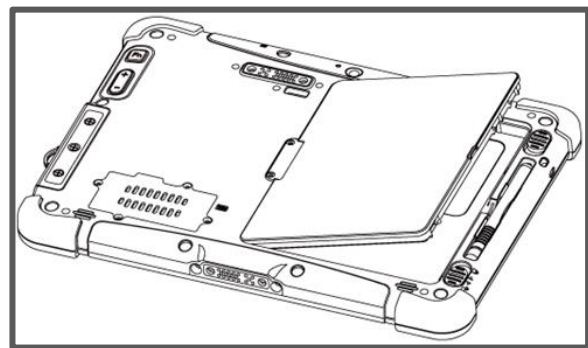
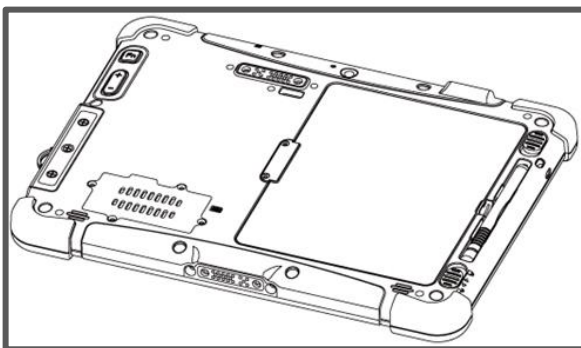

To remove the battery pack

1. Shut down the tablet (or put into sleep mode). Disconnect any cords connected to the computer.
2. Turn the tablet computer over, back facing up.
3. Locate the Battery Lock Latch and push it to the “Unlocked” position.
4. Locate the Battery Release Slider that is spring-loaded. Pull back and hold.
5. Lift the battery out using the opening on the side of battery compartment.

Charging Your Tablet

The Tablet operates either on external AC power or internal battery power. It is recommended to use AC power when you start up the Tablet for the first time.



Caution: Use only the AC adapter included with your Tablet Computer. Using other AC adapters may damage the Tablet Computer and the Battery.

To connect a tablet to AC power:

1. Open I/O protective cover by pulling out the latch.
2. Plug the DC cord of the AC adapter into the power jack of the tablet computer.
3. Plug the AC power cord into the AC adapter.
4. Plug the AC power cord into the electrical outlet.

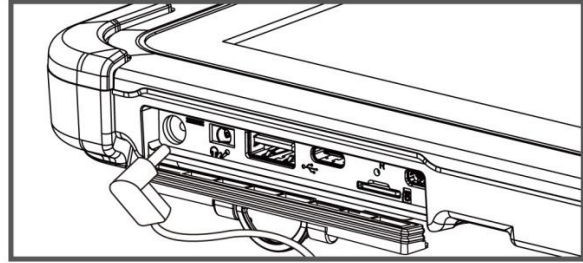
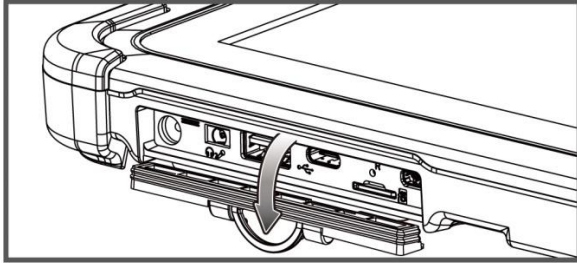

The battery LED indicator shows different battery states:

- Orange** - AC adapter is plugged in and battery is charging.
- Green** - AC adapter is plugged in and battery is fully charged.
- Solid Red** - Low battery level (<10%).
- Blinking Red** - Battery is being hot swapped.
- No light** - Battery is in use and charged (>10%).

Starting the Tablet



Important: When powering on the device for the first time, please make sure there's no interruption during the Windows setting up process, for example, accidentally powering off. If it happened, please access the recovery menu by pressing **Fn1** button on the front bezel to initiate recovery process.

Press and hold the power button for **3 seconds** until the blue LED power indicator light up.



Note: Do not press the power button repeatedly.
Do not perform the following operations until the Disk Activity Indicator off

- Connecting or disconnecting the AC adapter
- Pressing the power button
- Touching the tablet buttons, screen, or external keyboard/mouse

To power off the Tablet Computer:

1. Make sure you have closed any programs that are open on the Desktop. Start Screen apps don't need to be closed.
2. Tap on the **Settings** charm.
3. Tap on **Power**.
4. Tap on **Shut Down**.
5. Wait for Tablet Computer to power off.



Note: The computer will forcibly be powered off if the power button is pressed and held for **6 seconds or longer**.

Using Hottab Utility

Hottab is the utility to control all main functions of your tablet computer. When Windows starts up, Hottab starts and runs on the background. To display the Hottab interface press the  (Menu) button located on the front panel or launch the application.

(Menu) Button on the Front Panel:

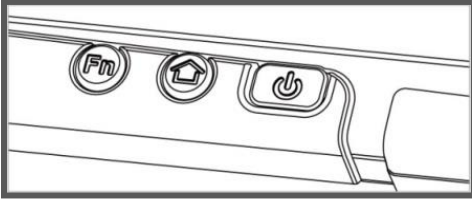





Hottab Utility Icon:

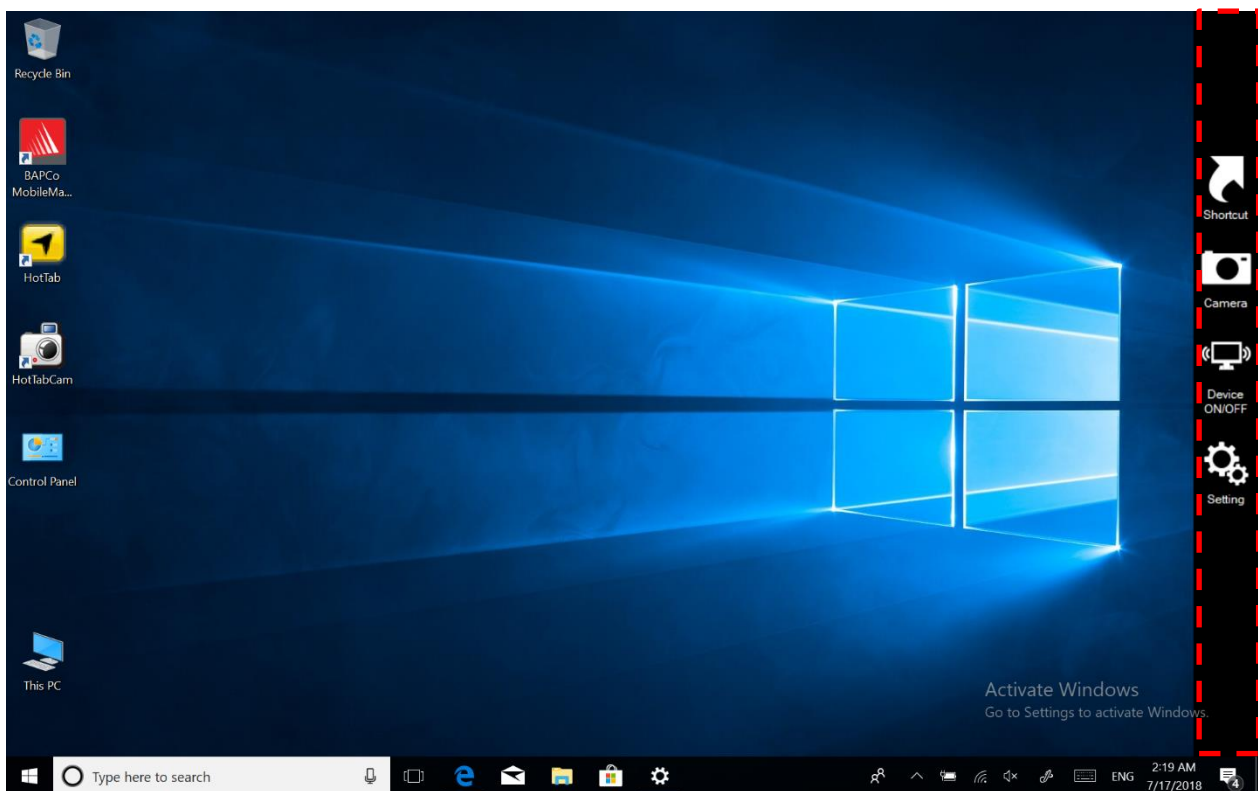



The main user interface is located on the right side of the screen. There are 4 main menu options: Shortcuts, Camera, Device ON/OFF, and Settings.



Icon	Description
 Shortcuts	Allows users to configure short cut to quickly access programs with a few tabs.
 Camera	Allows users take a picture or record a video. User can also adjust setting related to camera in this menu option.
 Device ON/OFF	Enables/disables tablet computer's hardware functions. The configurable functions are Wi-Fi, WWAN (3G/4G/LTE), GPS, Bluetooth, Camera, LED indicators, Barcode Reader, RFID Reader, and GPS Antenna routing options.
 Settings	Provides users information such as PC Information, Battery status, and also device settings such as power management setting, and function key mappings.

Using the Camera

To take photos or videos:

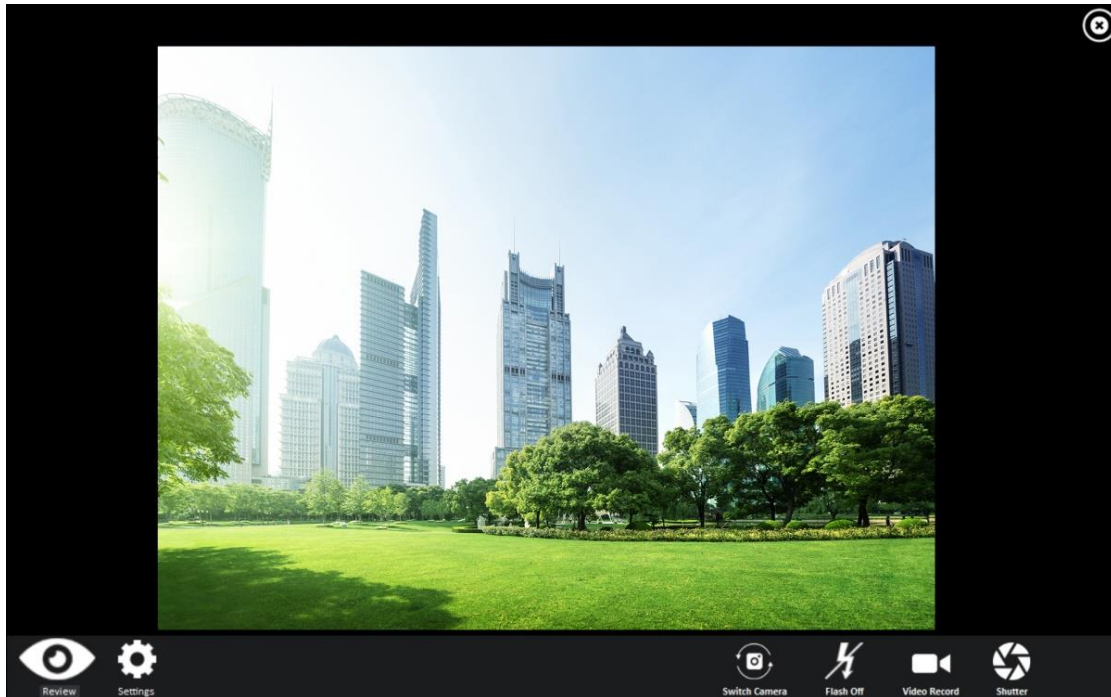

1. Open the Hottab application. The on-screen Hottab Camera Indicator lights orange.
2. Point the camera at an object.
3. Touch the on-screen shutter button  to take a photo or video record  button to record a video.



Changing Touch Mode

The tablet computer supports three built-in operating modes for different usage scenarios:

To change touch mode:

Mode	Description
 Hand/Rain (Default)	In <i>Hand/Rain</i> mode the touchscreen rejects false inputs from liquid drops. When the liquid is removed, the touchscreen accepts touch inputs from bare fingertips. <i>Supports input by:</i> <ul style="list-style-type: none"> • <i>Active stylus with palm rejection</i> • <i>Rubber tip passive stylus</i> • <i>Bare fingertips</i>
 Stylus	In <i>Stylus</i> mode, the touchscreen supports inputs from the fine-tip passive capacitive stylus (shipped with tablet). <i>Support input by:</i> <ul style="list-style-type: none"> • <i>Fine-tip passive stylus with palm rejection</i> • <i>Active stylus with palm rejection</i> • <i>Rubber tip passive stylus</i> • <i>Bare fingertips</i>
 Glove	In <i>Glove</i> mode, the touchscreen supports inputs while the user is operating the touchscreen with gloves on. <i>Supports input by:</i> <ul style="list-style-type: none"> • <i>Glove</i> • <i>Rubber tip passive stylus</i> • <i>Bare fingertips</i>

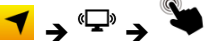
- a. Shortly press Function Key 1 (To define the function key refer to User Manual, Chapter 4).
- b. Press  (Menu) button on the front to open HotTab, or launch HotTab Utility application. Choose “Device ON/OFF, and then click “Touch Set” icon. 

Replacing Battery

The M101P Tablet supports hot-swap, meaning the tablet doesn't need to be powered off to replace the main battery. To support hotswap, there is a backup battery inside the tablet that is charged together with the main battery. This battery cannot be removed, and requires adequate power for main battery hot swapping. When the backup battery is fully charged, the tablet can sustain up to 5 minutes of runtime for battery hot-swapping.

Perform the following to hot swap the batteries:

1. Power on the tablet, open Hottab to check the power level of the Backup battery.
2. If the Backup battery level is "Low", please charge the tablet with AC Power until the Backup battery level is "Medium" or "High", and do not remove the main battery.
3. If the Backup battery level is at "Medium" or "High", you can remove the main battery.
4. Insert a new fully charged battery into the battery compartment.
5. Pen Hottab to check Main battery level. If the battery level is displayed incorrect, check if the new removable battery is inserted properly.
6. If the battery level displayed correct, continue using the tablet.







Caution: Charge the built-in back-up battery every two months to keep battery health and prevent possible issues from battery over-discharge.

Scanning Barcodes

Depending upon configuration, barcode scanning can be performed using the built-in 1D/2D barcode scanner (**Note:** barcode scanner is an optional feature).

To set up a barcode scanner:

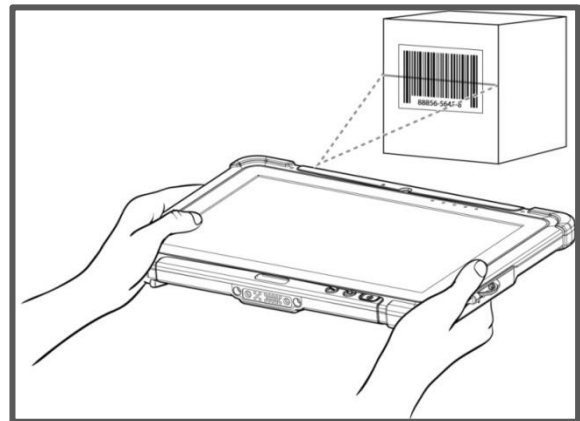

1. Tear off protective film from the barcode.
2. Press  Menu to open Hottab utility.
3. Choose Device ON/OFF  and click on Barcode .
4. Tap barcode power ON.
5. Press  button located on the rear.
6. Scan a barcode to check your reader is working properly. Result will be displayed in Hottab.



Reading RFID Tags

Depending upon configuration, the M101P supports reading RFID tags. The RFID antenna is located on the back of the device under the RFID logo.

To enable RFID Reader:

1. Press  Menu to open Hottab utility.
2. Choose Device ON/OFF  and click on .
3. Tap on the ON button. The button turns green, and the RFID icon in the Hottab menu is orange.
4. Bring the RFID card toward the antenna. Result will be displayed in Hottab

